

Collective Bargaining Agreement

Between the

STATE OF ALASKA



and the

**INLANDBOATMEN'S UNION of the PACIFIC
ALASKA REGION**



2011-2014

RULE 1 - SCOPE

1.01 The Rules contained herein constitute an Agreement between the STATE OF ALASKA, hereinafter referred to as the Employer, and the INLANDBOATMEN'S UNION OF THE PACIFIC, ALASKA REGION, representing the employees as classified within this Agreement, hereinafter referred to as the Union, governing wages, hours and conditions of employment on the Employer's ferries and any other waterborne carrier owned, operated, or leased for operation by the Marine Highway System, State of Alaska. The parties acknowledge that during the negotiations that resulted in this Agreement, each had the unlimited right and opportunity to make demands and proposals with respect to any subject or matter not removed by law from the area of collective bargaining and that this Agreement is the entire Agreement and includes all collective negotiations during its term except those that specifically arise through Rule 36.

1.02 Any additions, deletions or changes that are negotiated during the life of this Agreement shall be in the form of a written amendment or addendum and shall become part of this Agreement.

1.03 It is mutually understood that there is no desire on the part of the Union to dictate the business policies of the Employer but when the Employer contemplates a change in policy affecting the welfare of the employee, proper and reasonable notice shall be given to the Union. Should a dispute arise, it shall be settled in accordance with Rule 14.

1.04 - Labor Management Committee Purpose.

The purpose of labor-management committees, where established, is to facilitate communication between the parties and to promote a climate conducive to constructive Employer/employee relations.

Procedures

A joint labor-management committee may be established by written agreement at the executive level. Agreements establishing committees shall be entered into by the Division of Labor Relations and the Union.

Committees shall meet as agreed. Written agenda will be prepared and forwarded to the Division of Labor Relations and the Union in advance of all meetings.

Committees shall have no power to contravene any provision of this Agreement, to enter into any agreements binding the parties, or to resolve issues or disputes surrounding the implementation or interpretation of the Agreement. Matters requiring a contract

modification shall not be implemented until a written letter of agreement has been executed by the Union and the Employer.

No discussion or review of any matter by a committee shall forfeit or affect the time frames of any dispute resolution procedure contained in this Agreement. Issues that should be resolved through such procedures shall be referred to and handled pursuant to that procedure. Matters that have been submitted to any formal dispute procedure or that are in litigation shall not be discussed.

1.05 Commencing in calendar year 2005, the State of Alaska shall have the ability to contract for the passenger and vehicle service for the following ports: Angoon, Gustavus, Hoonah, Kake, Tenakee and Pelican and IBU jurisdiction shall not apply.

RULE 2 - RECOGNITION

The Employer recognizes the Union as the exclusive representative of all employees as classified herein, and as the sole collective bargaining agent for the purpose of acting for the employees in negotiating wages, hours, conditions of employment and interpreting this Agreement, and adjusting disputes.

RULE 3 - HIRING

3.01 The Employer may employ from any source, including the Union, but shall give first consideration to applicants who are residents of Alaska. If called upon to do so, the Union agrees to furnish the Employer qualified and satisfactory personnel for any classification covered by this Agreement.

3.02 The employer will notify the Union's Regional Office of each employee hired or separated within ten (10) working days of the action.

3.03 The Union agrees that all nonpublic personnel information provided to them by the Employer shall be used only for purposes related to the execution of the Agreement; and that the Union shall be responsible for the protection and security of information provided.

3.04 The Union will provide the Employer with an Employee Contact Form which the Employer will include in all "new hire" and "orientation" packets for unlicensed vessel employees. The Employer will return the contact form to the Union in a timely manner. Disputes arising under Rule 3.04 shall be processed only under the parties' complaint procedures.

RULE 4 - DEFINITIONS

4.01 - Employees

(A) ***Regularly Assigned Employee.*** An employee who has been awarded a specific position on board a given vessel in accordance with Rule 28 of this Agreement and who is working their Regularly Assigned Position.

(B) **Relief Employee.** An employee with a minimum of thirty (30) company seniority points who is working on an as-needed basis.

(C) **Seasonal Employee.** An employee who has less than thirty (30) company seniority points and who does not have a Regularly Assigned Position.

(D) **Regularly Assigned Relief Employee (RARE)** . An employee who has been awarded a bid job in a given classification to relieve Regularly Assigned Employees (RAEs) for vacation or sick leave, or to fill vacant bid positions in the given classification until the implementation of new bid awards.

Employees assigned as RAREs may be required to work irregular assignments without benefit of a scheduled week off.

(E) **Displaced Regularly Assigned Employee (DRAE).** A Regularly Assigned Employee (RAE) who is displaced in the work force.

(F) **Probationary Employee.** An employee who has not completed 1,092 hours in work status in the southeast system or 1,456 hours in work status in the southwest system.

(G) **Extra and/or Turnaround Employee.** An employee who is dispatched for less than a full workweek and is in addition to the minimum number of positions authorized by AMHS for the full workweek on the weekly crew list.

(H) **Inport Extra.** An employee who works on board an AMHS vessel while the vessel is in revenue service and in port. The Inport Extra will not be considered part of the sailing crew.

(I) **Reduction In Force.** Reduction In Force (RIF) is defined as any time an AMHS vessel is taken out of revenue service for a scheduled yard or lay up period with a scheduled return to revenue service. During the summer, emergency service or breakdown must be in excess of thirty (30) continuous days for this definition to apply.

(J) **Deadheading** is defined as transportation on vessels between regular ports of call in which the employee resides and the change port of the position to which assigned.

4.02 - Regularly Assigned Positions

Positions on board a given vessel and crew ("A" or "B") which are filled in accordance with Rule 28 of this Agreement.

4.03 - Vessels

(A) In Service. A vessel is in service when leaving overhaul, with sea watches set, and not conducting revenue operations.

(B) Revenue Service. An in service vessel is in revenue service when it is taking on paying passengers, vehicles or cargo.

RULE 5 - UNION MEMBERSHIP

5.01 Persons employed in the bargaining unit shall be notified by the Employer at the time of hire that they have fourteen (14) days to contact the appropriate Union office to be informed of the Union security provisions of this Rule. The employee shall contact the Union office on their own time and shall be introduced to the Inlandboatmen's Union of the Pacific, Alaska Region, (IBU) Ship's Delegate by the Purser.

5.02 All employees covered by this Agreement shall, within thirty (30) days after employment with the Employer, be or become members of the Union and shall thereafter as a condition of employment tender the dues and initiation fees or other fees as required by AS 23.40.220.

5.03 The Union shall advise the Employer in writing the amount of its initiation fee and monthly dues as duly adopted by its membership. The Employer, with the written consent of the employee, shall deduct monthly from the pay of each employee covered by this Agreement such fee or dues for the preceding month and remit the amount monthly to the Treasurer or other officer of the Union as may be designated in writing by the Union.

5.04 Upon notice by the Union that an employee has been employed for more than thirty (30) days and is not in compliance with the provisions of this Rule and demonstration by the Union that it has provided employee with the procedural protections required by law the Employer shall terminate the employee. Termination shall become effective within thirty (30) days after receipt of the aforesaid notice to the Employer by the Union.

The Union shall defend, indemnify, and save the Employer harmless against any and all claims, demands, suits, grievances or other liability (including attorney's fees incurred by the Employer) that arise out of or by reason of actions taken by the Employer pursuant to this section, except those actions caused by the Employer's negligence. If the Union undertakes the defense under this section, it shall at its option select counsel to conduct the defense.

5.05 The Employer agrees not to discriminate against any employee for membership in the Union or activity in behalf of the Union, provided such activity is not contrary to law or this Agreement.

5.06 Each crew shall have a ship delegate designated in writing by the Union to check overtime and pay discrepancies and to handle shipboard disputes. The Union and all ship delegates will be provided a copy of all office directives pertaining to changes in work rules or conditions of employment. The Union will notify the Employer in writing of any changes in designation of ship delegates.

RULE 6 – NONDISCRIMINATION

6.01 The Employer and the Union agree that there will be no unlawful discrimination against any employee or applicant for employment because of race, religion, disability, marital status, change in marital status, pregnancy, parenthood, sex, color, age, genetic information, or national origin.

6.02 All references herein to the male gender will also include the female gender.

RULE 7 - CREW REQUIREMENTS

7.01 The minimum crewing requirements for each vessel shall be in accordance with the Certificate of Inspection issued by the Coast Guard under which the vessel is licensed to operate.

7.02 The Employer and the Union agree that every effort will be made to crew the vessels of the Employer with the minimum crew required in Rule 7.01. Summer positions will be filled on the closest crew change date prior to June 1, and will be carried onboard to the closest crew change date following September 15. A weekly crew list will be prepared by the personnel section of the Alaska Marine Highway System identifying the minimum authorized number of positions to be filled. If it is necessary that an employee must work on off-duty hours due to a missing crew member or members, the employee shall be paid overtime for this work in accordance with Rule 22.

7.03 It is recognized that the Employer retains the right to transfer crew members between vessels to accommodate peak traffic loads, absences, changes in scheduling or other valid business needs. Except in cases of emergency, the affected crew member will be notified in writing of such transfers at least one (1) week in advance of the scheduled transfer date. Notice of transfer shall be sent to the Union at the time such notice is provided to the employee. The Employer shall make every effort to minimize such transfers for classifications above the entry level by the temporary upgrade of employees, whenever practical.

7.04 (A) During lay-up, shipyard, drydocking or maintenance status of a vessel, security work will be performed by the crew of the vessel, whenever AMHS crewmembers are assigned and living aboard the vessel.

(B) By "crew" of the vessel the IBU-P considers members of the MM&P and MEBA units that are part of the operational crews of the vessels to be part of the crew. It is not the intent of this bargaining unit to displace any members of these other bargaining units when it comes to doing security work. If the need arises to have additional crew onboard or there is not sufficient members from the other units available it is expected IBU-P personnel will be used.

(C) When a vessel is "turned over" to a shipyard for a federally funded project, or is to be mothballed for five (5) months or more, it will be at the State's discretion whether or not crew will be assigned to the vessel while in the hands of the shipyard.

7.05 If the State of Alaska, Alaska Marine Highway System provides services onboard it's vessel, then IBU employees shall perform those services, therefore not allowing AMHS to contract out any current service onboard it's vessels.

7.06 The IBU will provide steward service whenever a MMP or MEBA officer is assigned to and living aboard the vessel.

RULE 8 - HEALTH AND SAFETY

8.01 The health and safety of employees shall be reasonably protected.

8.02 The Employer agrees that on vessels where quarters are provided, that white sheets, pillow slips, mattresses, mattress covers, blankets and soap shall be furnished to insure sanitary and healthful conditions. Employees shall be responsible for and turn in soiled linen before being issued a clean supply. The mattresses and blankets of all crew members shall be cleaned as needed and replaced as required.

8.03 Employee physicals may be required by the Employer to be performed by a doctor of the Employer's choice and at the expense of the Employer. The Employer will provide at no cost or reimburse the employee for immunization against Hepatitis A, B, and C, where appropriate to the employee's regularly assigned duties. The parties will meet and confer to determine the positions for which any or all of these immunizations are appropriate.

8.04 The Employer will continue to provide advanced first aid training to selected unlicensed vessel personnel in the interest of passenger and crew safety. Safety devices and first aid equipment as may be needed for safety and proper emergency medical treatment will be available aboard ship.

8.05 There shall be safety meetings, called by the Master of the vessel, of the safety committee including the Union delegate and a representative of each department for the purpose of reviewing safety practices and programs at least once each month. Written recommendations will be responded to in writing by the Employer within thirty (30) days. The ship's delegate and the Union will receive a copy of the minutes and response.

8.06 It shall not be a violation of this Agreement nor grounds for dismissal if an employee refuses to work on an unsafe job provided the job is found to be unsafe by the Marine Inspection Division of the US Coast Guard (USCG). Interim disciplinary action may be taken until the USCG has made a finding on safety. Interim disciplinary action shall be restricted to full documentation of the circumstances.

8.07 - Safe Work Practice

(A) No lashing or unlashng of vehicles shall be done while the vessel is underway except for the safety of the vessel and its cargo.

(B) When unlicensed personnel are assigned to work inside the elevator or dumb-waiter shafts at least two (2) crew members shall be assigned.

(C) Crew members shall not work on portable ladders, staging or any other contrivance that elevates the employee above the deck when the vessel is underway except in case of an emergency.

(D) No work shall be required to be performed on the ship's funnel or stack while main engines are in operation except in emergency.

(E) There shall be no inside painting without proper ventilation.

(F) Any dust-producing work, especially sawing and equipment grinding of asbestos-containing materials or removal of lagging, shall be done with "NIOSH" approved safety equipment. Any work on asbestos containing materials shall be performed by certified asbestos workers.

8.08 - Safety Certifications

(A) All employees will be encouraged to obtain a US Coast Guard Proficiency in Survival Craft certificate and a STCW Certificate for the Proficiency in the use of survival craft within six months from the date of meeting the necessary Coast Guard sea time requirements. All employees shall be required to obtain the Proficiency in Survival Craft certificate and an STCW Certificate for the proficiency in the use of survival craft within one year after completing the necessary sea time requirements as a condition of continued employment with the Employer. The parties agree to meet and confer regarding the effect of new or revised safety regulations.

(B) Employees shall not be dispatched to positions listed on the Station Bill unless they possess the required qualifications.

8.09 The Employer will provide safety items and apparel as required for the safe performance of the job. Such items shall include where necessary, hard hats, safety goggles, ear protection devices, welder's apparel, safety harness for going aloft, and breathing devices. Employees refusing to wear the proper items may be subject to disciplinary action.

8.10 The parties recognize that certain employees may, in the performance of their duties, come in contact with asbestos. When an employee provides evidence to the Employer of having undergone an examination for asbestosis, the Employer will reimburse that employee one hundred and five dollars (\$105.00). To qualify for reimbursements as provided above, the employee must show proof of the examination within six months of the examination. No more than one (1) such reimbursement will be paid to an employee in any twelve (12) month period.

8.11 The Employer will maintain a record of an employee's training that meets US Coast Guard regulations. The Employer will provide the employees training record to the employee upon request.

RULE 9 - OCCUPATIONAL INJURY AND ILLNESS BENEFITS

9.01- Unearned Wages

In the event an employee becomes ill or is injured while in the service of the Employer's vessel, the employee shall receive wages and benefits until returned to their change port or employee's port of residence, whichever is soonest. During the period of time that an employee is receiving unearned wages for a work related illness or injury, the employee may not receive additional income supplementation by claiming accrued annual leave or medical/sick leave. In order to receive unearned wages employees must submit an Unfit for Duty form within seventy-two (72) hours from leaving the vessel.

9.02 - Transportation

In the event an employee becomes ill or is injured while in the service of the vessel, they will be furnished meals, lodging and transportation by AMHS vessel until returned to their change port. This provision shall apply only when the employee is not hospitalized and has notified the vessel department head or the Port Captain's Office of their medical status. If determined by the Medical Person in Charge (MPIC) that the employee has a serious illness and the employee cannot be returned to their change port by an AMHS vessel within twenty-four (24) hours the Employer will provide commercial transportation.

9.03 When hospital treatment is required, transportation to and from the hospital will be furnished by the Employer if the employee becomes ill or needs medical attention while in the service of the vessel and a Master's certification has been issued. Upon release from the hospital, transportation to the employee's change port shall be provided upon request, provided said transportation is connected to an assignment.

9.04 Seniority shall accrue while the employee is paid Worker's Compensation benefits for the time absent from work providing the employee was eligible for dispatch based on their seniority.

9.05 The Employer shall provide the Union with written notice of all job-related injuries in a timely manner.

RULE 10 - COMPENSATION FOR LOSS OF EFFECTS

10.01 In the event of shipwreck, stranding, sinking, burning, flooding or collision of the vessel, crew personnel will be reimbursed for loss of personal effects, instruments, and equipment in the amount up to two thousand dollars (\$2,000). Each crewmember must provide the Employer with an itemized list of their losses

including replacement values. Reimbursement may be made for items over \$2000 up to \$5000 if supported by receipts.

RULE 11 - CASH ALLOWANCE FOR SUBSISTENCE AND QUARTERS

11.01 When the employee is in work status away from home and quarters are not furnished, the employee shall be entitled to a quarters allowance of ninety-five dollars (\$95.00) per day between May 16 and September 15 and eighty-five dollars (\$85.00) per day between September 16 and May 15.

In the event that quarters are not available at the contracted quarters allowance rate the employee shall be reimbursed for necessary receipted expenses for quarters.

11.02 When an employee is in work status away from home and meals are not furnished, the employee shall be entitled to a meal allowance in accordance with the State Administrative Manual. In the event that the rate for meal allowance designated in the State Administrative Manual for Southeast Alaska is increased, the rate specified herein shall be increased by the same dollar amount.

RULE 12 - CHANGE PORTS AND TRAVEL BETWEEN ASSIGNMENTS

12.01 - Change Ports

Currently, regularly assigned change ports in Southeast are Juneau, Ketchikan, Metlakatla, and in Southwest are Cordova, Valdez and Homer. Each Regularly Assigned Position shall have a designated crew change port. Changes in these change ports shall be designated by the Employer. Should the Employer make a change to the change port of a vessel, moving costs or travel expenses will be paid for affected crewmembers in accordance with Rule 12.09. The Employer will determine whether moving costs or travel expenses are to be paid on a case by case basis. All employees shall utilize only the designated change port for the position to which assigned, unless specifically exempted in writing by the Employer.

12.02 - Responsibility to Relieve

It shall be the employee's responsibility to relieve as scheduled. Failure to relieve as scheduled may be grounds for disciplinary action, including possible discharge, unless such failure to relieve has been approved at least twenty-four (24) hours in advance by the Ketchikan personnel dispatcher. Exceptions will be made in cases of sudden illness or accident-related emergencies. Routine medical, dental or personal business appointments shall not be considered an emergency. When crew change occurs on weekends, prior notification of unavailability will be given to the dispatching personnel by the close of business on Friday. The Employer shall not be liable for travel and/or other expenses incurred by employees traveling to or from their assignments, except as specifically provided in this Agreement.

12.03 - Relief At Other Than A Regularly Assigned Change Port

When an employee is relieved or assigned at a port other than a regularly assigned change port, the employee is entitled to receipted necessary travel expenses or

airfare equivalent, whichever is less, and travel pay based on air travel, to return to the regularly assigned change port in which the assignment began.

12.04 - Travel Between Assignments

(A) To Regular Assignments. If a Regularly Assigned Employee resides at a port other than the designated change port for their position, the employee shall be obligated to deadhead or travel at their own expense to be available at the designated change port to relieve when scheduled to do so.

(B) To Temporary Assignments. If a Regularly Assigned Employee is temporarily assigned duties which involve a crew change or work assignment at other than their regularly assigned change port, the employee is entitled to travel pay and receipted necessary travel expenses for travel between the employee's regularly assigned change port and the temporary change port.

(C) When an employee is entitled to necessary travel expenses (including air fare and ground transport) these expenses will be paid in accordance with the Alaska Administrative Manual. Employees choosing to travel at another time or using means other than that provided by the Employer will be reimbursed for receipted expenses up to the dollar amount of the travel that would have been provided by the Employer. All requests for reimbursement must be submitted within sixty (60) days from the employee's release from the vessel. Travel expenses will not be paid for the portion of travel provided by the Employer on its vessels.

12.05 - Travel Between Assignments -- Displaced Regularly Assigned Employees, Relief, and Regularly Assigned Relief Employees

Relief Employees, RAREs, and DRAEs shall identify a designated change port, either Juneau or Ketchikan. When a Relief Employee, RARE, or DRAE receives an assignment at other than the employee's designated change port, the employee shall receive receipted necessary travel expenses for travel between the assignment and the designated change port.

12.06 - Travel Between Assignments -- Seasonal Employees

Seasonal Employees may "deadhead" to and from the assigned change port for the position which they are relieving, but will not be paid air transportation, travel expenses or travel pay. This applies to assignments or reliefs made at the regularly assigned change ports.

12.07 - Deadheading

Deadheading may be permitted at the commencement and termination of each assignment. Employees who are permitted to deadhead may take meals without charge. Berths will be furnished free of charge whenever possible on a space-available basis, but the Employer shall not be liable for travel and/or other expenses incurred by an employee traveling to the employee's change port by means other than vessels of the System. The Employer agrees to eliminate deadheading whenever and wherever possible, if no additional cost such as early call back or minimum guarantee is involved, and if it is mutually agreeable between the Union and the Employer.

12.08 - Travel Pay

When an employee is eligible for travel pay as provided elsewhere in this Rule, it shall be computed on the basis of straight-time pay for the actual hours involved in traveling to or from an assignment. Employees will receive a minimum of four (4) hours travel pay per trip, including time worked on assignment during the same day. Employees will receive a maximum of twelve (12) hours travel pay in any twenty-four (24) hour period, regardless of mode of travel involved. Travel pay time begins at airline check-in time, when air transportation is used, or at the scheduled departure time of the Employer's vessel, when necessary or directed to travel by vessel. Travel pay ends upon arrival at the port of destination, if the assigned vessel is in port. If the vessel is not in port, travel pay ends upon arrival of the vessel. When it is necessary to await arrival of the vessel, Rule 11, Cash Allowance for Subsistence and Quarters, will apply. Claims for subsistence shall be made on Form 02-027, State of Alaska Travel Authorization. Travel time will apply towards minimum guarantee but shall not be included in straight-time hours in determining when overtime will commence.

12.09 - Transfer or Changes of Assignment

All additional costs incurred by a transfer or change of assignment at the convenience of and request by an employee shall not be the responsibility of the Employer. This includes transfers caused by initiation of a bid award and employees' costs incurred upon returning to their regularly assigned positions after a reduction-in-force period. Expenses incurred when a transfer or permanent change of assignment of a Regularly Assigned Employee is at the direction of and for the convenience of the Employer shall be the responsibility of the Employer. When employees are permanently transferred for the convenience of, and at the direction of the Employer, other than through the bid process to work assignments in Southwest Alaska from a Home Port within the Southeast System (or vice versa), or due to the Employer making a change in change ports, reimbursements for actual moving expenses incurred shall be in accordance with the State travel regulations.

12.10 - Temporary Assignments Between Designated Change Ports

The parties agree to allow temporary assignment changes between designated change ports in order to eliminate deadheading and reduce travel expenses.

12.11 The Inport Extra Employee will be entitled to one (1) hour travel pay per assignment.

RULE 13 – VISITATION

Authorized representatives of the Union shall be allowed to go on the Employer's property and on board vessels covered by this Agreement. The Employer will issue the duly accredited representatives a visitor pass for such visits, and the Union agrees that the Employer is absolved from all claims resulting from any accident involving such representatives while on the property or on board vessels of the

Employer. No individual or group of employees will be interrupted in their work without prior approval of the Vessel Master.

RULE 14 - SETTLEMENT OF DISPUTES

14.01 It is desired that differences between employees and supervisors be resolved quickly and satisfactorily as possible. To achieve this goal, employees are encouraged to discuss such differences with their supervisor as soon as they are aware of the event leading to the difference and prior to the filing of a grievance. Supervisors are similarly encouraged to be responsive to such discussion. Adjustments may not conflict with this Agreement or applicable written laws or regulations and shall not be precedential. The dispute may be brought to the attention of the Vessel Master within forty-eight (48) hours of the action or inaction. Failing resolution, the Vessel Master shall have ten (10) calendar days to respond in writing to the employee.

Such discussion is at the employee's option. Regardless of whether this option is exercised the time limits for filing a grievance or complaint shall be adhered to. This means that if the Vessel Master has not responded or if the employee is not satisfied with the Vessel Master's response, the Union must file a written grievance or complaint at Step One within the time limits set forth in the provisions of Rule 14.02 or 14.03.

14.02 - Grievance Procedure

A grievance shall be defined as any controversy or dispute involving the application or interpretation of the terms of this Agreement arising between the Union or an employee or the employees and the Employer. The Union or the aggrieved employee or employees shall use the following procedure as the sole means of settling grievances.

(A) To qualify for consideration under the grievance procedure set forth in this Rule, the grievance shall be brought to the attention of the Employer through the Union in writing within thirty (30) calendar days of the occurrence of the disputed action or inaction, or of the date the employee is made aware of the action or inaction, whichever is later. The appeal of a dismissal, demotion or suspension must be brought to the attention of the Employer through the Union in writing within fifteen (15) calendar days of the date the employee is notified of the action.

(B) Written grievances at Steps One through Three shall be processed on forms provided by the Employer and shall, at all levels of the grievance procedure, cite specific rules alleged to have been violated and relief sought. All time limits expressed herein may be extended by mutual agreement of the parties, but it is understood that time is of the essence and that grievances must be timely appealed in order to utilize this grievance procedure.

(C) STEPS IN THE GRIEVANCE PROCEDURE

STEP ONE: Within thirty (30) calendar days of the disputed action or inaction, or the date the employee is made aware of the action or inaction, whichever is later, the Union may submit a grievance in writing to the AMHS General Manager. The AMHS General Manager shall attempt to resolve the matter and shall report the decision to the Union in writing within fifteen (15) working days of its presentation.

STEP TWO: Failing to settle the grievance at Step One, the appeal may be submitted in writing by the Union to the Commissioner of Transportation and Public Facilities within fifteen (15) working days after the response from the AMHS General Manager is due or received, whichever is earlier. The Commissioner of Transportation and Public Facilities or designee shall respond in writing within fifteen (15) working days after receipt of appeal.

STEP THREE : Failing to settle the grievance at Step Two, the appeal may be submitted in writing by the Union to the Commissioner of Administration within fifteen (15) working days after the response from the Commissioner of Transportations and Public Facilities is due or received, whichever is earlier. The Commissioner of Administration or designee shall respond in writing within twenty (20) working days after receipt of appeal.

STEP FOUR : If a dispute over the correct interpretation or application of this Agreement remains unresolved after being timely processed through the preceding steps, it shall proceed to binding arbitration if the Union so requests within thirty (30) calendar days after the date of the response from the Commissioner of Administration is due or received, whichever is earlier. Such request shall be made in writing to the Director of Division of Personnel and Labor Relations or designee and shall specify which Rule or Rules are alleged to have been violated and the specific nature of that violation.

(D) Within ninety (90) days after the signing of this Agreement the Employer and the Union shall jointly request from the Federal Mediation and Conciliation Service the names of twenty-one (21) qualified arbitrators in the Pacific Northwest United States. From this list of arbitrators the Employer and the Union shall alternately strike from the list one name at a time until seven names remain on the list. Thereafter, on each occasion requiring an arbitrator, the parties will promptly select the arbitrator by alternately striking names from the list until only one (1) name remains. The party requesting arbitration shall strike the first name. The last name remaining on the list shall be the arbitrator, and arbitration shall commence on a date to be selected by agreement of the arbitrator and the parties.

(E) The arbitrator shall issue a decision and award in writing within thirty (30) calendar days after the close of the hearing, which decision and award shall be final and binding on each of the parties. The arbitrator shall have no authority to rule contrary to, amend, add to, subtract from or eliminate any of the terms of this Agreement. The arbitrator shall have the power to return a grievant to employee status with or without restoration of back pay or mitigate the penalty as equity suggests under the facts if a contractual violation is determined by the arbitrator. Should either party fail or refuse to abide by the decision of the arbitrator, the

other party shall be free to petition to the Labor Relations Agency for enforcement of the Agreement.

(F) In any arbitration proceeding held pursuant to this Rule the expenses incident to the services of the arbitrator shall be borne entirely as designated by the arbitrator. The arbitrator shall assign such expense to the losing party. If, in the opinion of the arbitrator, neither party can be considered the losing party, then such expenses shall be apportioned as in the arbitrator's judgment is equitable.

14.03 - Complaint Procedure

A complaint is defined as: 1) any controversy, dispute or disagreement arising between the Union or an employee(s) and the Employer that does not concern the application or interpretation of the terms of this Agreement, or 2) is the appeal of the discharge or discipline of a probationary employee not holding permanent status in any classification. The following shall be the sole means for settling complaints.

(A) A complaint must be brought to the attention of the Employer consistent with the procedures set forth in this Rule within thirty (30) calendar days of the effective date of the action or inaction or the date the employee is made aware of the action or inaction, whichever is later (except as provided in Rule 14.01 regarding onboard disputes).

(B) Date of receipt of a complaint or response shall be either seven (7) calendar days following date of postmark or the date of a signed verification of receipt. Allotted time frames may be extended by mutual agreement.

(C) Complaints shall be processed on forms provided by the Employer and agreed to by the Union.

(D) The complaint will state the facts from which it arises, the rules, procedures or conditions which should be considered and the remedy requested. Adjustments to complaints shall not conflict with this Agreement or applicable written policies, laws or regulations.

(E) Appeals shall be in writing with a copy of the original complaint attached.

(F) STEPS IN THE COMPLAINT PROCEDURE

STEP ONE: Complaints will be presented on the provided forms by the Regional Director of the IBU-P to the AMHS General Manager. The General Manager shall respond in writing to the Union within ten (10) working days from receipt of the Step One complaint.

STEP TWO: Failing to resolve the complaint at Step One, the Union may appeal the complaint to the Commissioner of Transportation and Public Facilities within ten (10) working days after the response from the General Manager is due or received, whichever is earlier. The Commissioner of Transportation and Public

Facilities shall respond in writing within ten (10) working days from the receipt of the Step Two filing.

STEP THREE: If the complaint is unresolved at Step Two, the Union may appeal the complaint to the Commissioner of Administration within ten (10) working days after the response at Step Two is due or received, whichever is earlier. The Commissioner of Administration shall respond in writing within fifteen (15) working days from the receipt of the Step Three filing. The decision of the Commissioner of Administration is final and shall settle the matter.

14.04 There shall be no strikes, lockouts, sympathy strikes, slow downs or stoppages of work during the term of this Agreement, it being the intent of the Employer and the Union that all disputes be settled in accordance with the provisions of this Agreement. Notwithstanding this, however, no employee working under this Agreement shall be required to board any vessel of the Employer that is being picketed by any union in connection with a lawful primary strike sanctioned by the National President of the Inlandboatmen's Union of the Pacific.

14.05 An employee shall have the right to examine his/her own personnel file or files. Documents implementing penalties which are later reversed in the grievance-arbitration procedure shall be removed from the personnel file. The parties agree that this provision does not preclude the maintenance of such records in separate files, provided that such documents shall not be forwarded to potential employers within or outside State government.

RULE 15 - WORKING CONDITIONS

15.01 Employees shall perform all duties as assigned by their supervisors. Whenever possible and practical, the Employer will equalize the assignment of less desirable work.

15.02 One (1) employee from the deck department and one (1) from the engine department on an alternate basis, and one (1) employee from the steward's department will do sanitary work in their respective areas in the crew's head, showers and passageways in crew's quarters and will be allowed two (2) hours during their regular work hours to perform this work.

15.03 Tie-Up and Let-Go

When tying up or letting go, no less than two (2) employees shall be assigned to each line as it is being handled.

15.04 Taking on ship's fuel oil, lube oil, fresh water, and the handling of shore-to-ship and ship-to-shore power cables shall be the duties of the Junior Engineer and Wiper except on the M/V Aurora and LeConte will it be handled by the Oiler.

15.05 During the peak meal hours one (1) additional employee may be assigned when required to assist the crew waiter at the discretion of the Chief Steward. No watchstander shall be required to report for watch duty nor retire from watch duty without being served meals, provided that the member reporting for watch reports to the crew mess at least twenty (20) minutes prior to commencement of their watch and the relieved member proceeds directly to the crew mess.

15.06 Crew members called out for the tie-up and let-go shall assist with loading and unloading and lashing of vans as necessary and may be used for other lawful duties.

15.07 The Employer agrees that sea watches shall not be broken when in-service vessels are laying over due to a schedule change. It is recognized that watchstanders may be temporarily reassigned as dayworkers in order to increase productivity during these temporary layovers.

15.08 When engine room day workers are required to work between the hours of 2200 to 0600 and cannot receive a six (6) hour break before the scheduled reporting time for their next shift the starting time of the shift may, at the employee's option, be delayed until a six (6) hour break has been taken.

15.09 No ship scaling or other noise-producing work will be performed before 0600 or after 2000.

15.10 Watchmen may be required to do such work or other duties that are normally assigned to Able Bodied Seamen or Ordinary Seamen.

15.11

(A) Oilers and Junior Engineers may be required to perform normal wiper duties only on the M/V LECONTE and the M/V AURORA, without the payment of overtime.

(B) Oilers shall not be required to perform any maintenance work while the vessel is underway and they are on watch.

15.12 Only sanitary work shall be performed on Sundays or holidays and between the hours of 1800 and 0600. Such work shall consist of the following: cleaning pilot house and pilot house windows, cleaning crew's heads and showers, cleaning crew's passageways, cleaning stairwells, hosing down car deck, dumping refuse buckets, sweeping and mopping floor plates, cleaning up loose oil.

This Rule does not apply to persons engaged solely for the purpose of servicing the passengers or crew; nor employees engaged in work in connection with navigation, loading or unloading, tying up and untying the vessel or normal duties performed by the Junior Engineer.

15.13 - Formal Training

(A) Employees undergoing employer-directed, instructor facilitated training will receive travel allowances in accordance with Rule 11 and will be provided

transportation in cash or in kind. "Employer directed training" for the purpose of this rule shall be a written, employee specific travel and training authorization.

(B) Employees residing within fifty (50) road miles of the training site will not be entitled to travel or transportation under this Rule.

(C) Minimum Guarantee shall not apply, except for recurring training required by the Employer that exceeds thirty-five (35) hours of instruction per week at intervals of thirty-six (36) months or less.

(D) Employees will be paid for actual training time. Regularly Assigned Employees will be paid at the straight-time rate of their bid job and all others will be paid at the rate of their last assignment.

(E) Employees may be reimbursed for tuition for other than Employer-directed training.

RULE 16 - SHIPYARD, LAY-UP, AND TERMINAL WORK

16.01 When vessels are tied up and watches are broken, such as at a shipyard, lay-up, or tie-up terminal, those crew members assigned to work on the vessel shall work a forty-two (42) hour workweek. The change in work schedules from ship's watch time to shipyard, lay-up, or tie-up time shall occur at the nearest noon or midnight after leaving service and at the nearest noon or midnight before entering service. During such periods employees shall be paid for the first forty-two (42) hours of work at the straight-time rate and Rule 25 shall apply.

16.02 All time worked during a forty-two (42) hour workweek assignment in excess of eight and four-tenths (8.4) hours per day or five (5) consecutive days of forty-two (42) hours per week shall be paid at the overtime rate of one and one-half (1-1/2) times the straight-time rate of pay. In computing weekly hours, the ship's watch time on the eighty-four (84) hour workweek schedule and shipyard, lay-up or tie-up time on the forty-two (42) hour week schedule shall not be combined. Upon leaving shipyard, lay-up or tie-up status, overtime for sea time will commence after completion of the regular seven (7) day, eighty-four (84) hour workweek.

16.03 Any crew members assigned to vessels which are tied up at shipyards, lay-up or tie-up terminals who are working a forty-two (42) hour week performing repairs, maintenance work, maintaining heating and maintaining ship's security over weekends may be assigned to work periods of five (5) consecutive days on duty and two (2) consecutive days off duty and will not receive overtime penalty pay as such for working Saturday or Sunday. If called back on their assigned days off, (after having worked a full five (5) day workweek) they will be paid for actual hours worked at the overtime rate of pay. Department supervisors will first seek volunteers for work on assigned days off prior to ordering employees to work overtime hours. Assigned days off refer to two (2) consecutive days off duty only.

16.04

(A) On vessels with adequate or sufficient staterooms and numbers of crew quarters, all IBU crew members assigned to a vessel in shipyard or lay-up status will be assigned single occupancy quarters during the period.

(B) Crew members assigned to occupy passenger staterooms will, prior to moving back to assigned crew quarters, clean the stateroom used to the satisfaction of the Chief Mate, Chief Steward, and IBU's Ship Delegate. Use and cleaning of passenger staterooms so used shall be at no cost to the Employer. An employee occupying such quarters may be liable for any damages caused by the employee's occupancy, normal wear and tear excepted, and damage to quarters may be grounds for immediate relocation and disciplinary action.

(C) It is recognized that operational requirements will necessitate the movement of crew members from one (1) room to another during the shipyard or lay-up period. Also, it may be necessary to require crew members to double up in the event of major repairs or refurbishment. Should these events occur it is agreed that there will be no penalty against Management for taking these actions.

(D) All revenue spaces are to be vacated promptly upon notification by Management. This will normally be ten (10) days prior to returning the vessel to service.

16.05

(A) When crew members are quartered aboard ship, no ship hull grinding, chipping or otherwise excessive noise-producing work will be accomplished after 2000 and before 0800 or on Saturday and Sunday. Normally, there will be no painting between the hours of 1700 and 0800 when crews are quartered aboard the vessel. A sanitary system including hot and cold water is to be available and in operation no later than four (4) hours after drydocking or 2000, whichever is later, unless mutually agreed to by the Union and the Employer.

(B) When the Vessel Master determines, after inspection, quarters are uninhabitable because of noise, fumes, or other environmental considerations the crew will be provided quarters ashore in kind or by payment of a lodging allowance. The Master's written determination will be given to the vessel IBU delegate or designee. Disputes will be resolved by the General Manager or designee whose decision will be final. After the fact determinations will not be made.

16.06 There shall be no splitting of shifts for personnel while in shipyard or lay-up, provided that no additional costs or personnel are required.

16.07 During annual lay-up and yard periods, a crew member may arrange to trade with another crew member on another vessel providing no overtime or shortage pay shall be paid by the Employer for such a trade and any such arrangement will be mutually agreed to in writing by the employees involved and the Employer prior to such a trade. These trades are subject to prior written approval of the Labor/Management Relief Assignment Committee.

16.08 If a vessel is scheduled to leave service for any reason, as much notice as possible will be given to the crew members. Such notice shall include the date and place of lay-up.

16.09 Displaced Regularly Assigned Employees shall accept available assignments to their assigned out- of-service vessel before being temporarily assigned to in-service vessel.

RULE 17 - PAY PLAN

17.01 This Agreement includes a pay plan providing a cost-of-living differential between employees living in the State and those living outside the state in accordance with AS 23.40.210.

Cost of Living Differential (COLD) payments are a geographical differential which reflects the difference in the cost of living in Alaska and Seattle, Washington. An employee establishes eligibility for COLD payments by establishing and maintaining their principal place of abode within the State.

Proof of eligibility for COLD payments must be filed annually on a form provided by the AMHS. The Employer may require an employee to provide additional documentation to support claims of eligibility for COLD payments. It shall be the employee's obligation to notify the Employer when they relocate their principal place of abode in a manner which affects eligibility for COLD.

(A) Salaries for Alaska residents, effective July 1, 2011:

CLASSIFICATION	STRAIGHT-TIME HOURLY	OVERTIME HOURLY
Chief Purser	\$ 29.77	\$ 44.66
Senior Assistant Purser	\$ 26.41	\$ 39.62
Junior Assistant Purser	\$ 22.61	\$33.92
A/B Bos'n	\$ 26.59	\$ 39.89
Able Seaman	\$ 24.34	\$ 36.51
Ordinary Seaman	\$ 22.80	\$ 34.20
Ordinary Seaman- Porter	\$ 22.80	\$ 34.20
Watchman-Porter	\$ 22.80	\$ 34.20
Junior Engineer	\$ 27.56	\$ 41.34
Oiler	\$ 25.27	\$ 37.91
Wiper	\$ 22.98	\$ 34.47
Chief Steward	\$ 29.77	\$ 44.66
Second Steward	\$ 26.41	\$ 39.62
Storekeeper	\$ 25.49	\$ 38.42
Chief Cook	\$ 27.12	\$ 40.68
Second Cook	\$ 23.85	\$ 35.78

Assistant Second Cook	\$ 22.61	\$ 33.92
Bartender	\$ 22.61	\$ 33.92
Headwaiter	\$ 22.61	\$ 33.92
Head Bedroom Steward	\$ 22.61	\$ 33.92
Mess Steward	\$ 22.52	\$ 33.78
Cashier/Gift Shop Operator	\$ 22.52	\$ 33.78
Officer's B/R	\$ 22.35	\$ 33.78
Waiter/Waitress	\$ 22.35	\$ 33.78
Steward	\$ 22.35	\$ 33.53

(B) Salary schedule for employees residing outside Alaska, effective July 1, 2011:

CLASSIFICATION	STRAIGHT-TIME HOURLY	OVERTIME HOURLY
Chief Purser	\$ 24.63	\$ 36.95
Senior Assistant Purser	\$ 21.56	\$ 32.34
Junior Assistant Purser	\$ 18.44	\$27.66
A/B Bos'n	\$ 21.73	\$ 32.60
Able Seaman	\$ 19.86	\$ 29.79
Ordinary Seaman	\$ 18.60	\$ 27.90
Ordinary Seaman-Porter	\$ 18.60	\$ 27.90
Watchman-Porter	\$ 18.60	\$ 27.90
Junior Engineer	\$ 22.51	\$ 33.77
Oiler	\$ 20.63	\$ 30.95
Wiper	\$ 18.76	\$ 28.14
Chief Steward	\$ 24.63	\$ 36.95
Second Steward	\$ 21.56	\$ 32.34
Storekeeper	\$ 20.86	\$ 31.29
Chief Cook	\$ 22.11	\$ 33.17
Second Cook	\$ 19.44	\$ 29.16
Assistant Second Cook	\$ 18.44	\$ 27.66
Bartender	\$ 18.44	\$ 27.66
Headwaiter	\$ 18.44	\$ 27.66
Head Bedroom Steward	\$ 18.44	\$ 27.66
Mess Steward	\$ 18.36	\$ 27.54
Cashier/Gift Shop Operator	\$ 18.36	\$ 27.54
Officer's B/R	\$ 18.36	\$ 27.54
Waiter/Waitress	\$ 18.29	\$ 27.44

Steward

\$ 18.29

\$ 27.44

(D) Effective July 1, 2012, the straight time hourly rate of pay (in effect June 30, 2012) for all classifications shall be increased by two percent (2%).

(E) Effective July 1, 2013, the straight time hourly rate of pay (in effect June 30, 2013) for all classifications shall be increased by one percent (1%).

17.02 Probationary employees who are working in one (1) of the Steward entry-level classifications shall be paid at 90 percent of the hourly rates established for that classification. Beginning with the first pay period in the month following when the employee completes the probationary period, the employee shall receive 100 percent of the hourly rates established for that classification.

17.03

(A) Upon request, one (1) Sailor's draw may be granted to an employee, of up to 50 percent gross straight-time wages earned at the time of the draw, not to exceed one thousand dollars (\$1,000.00).

(B) Upon request in shipyard, one (1) Sailor's draw per week may be granted to an employee of up to 50 percent gross straight-time wages earned at the time of the draw, not to exceed five hundred dollars (\$500.00).

(C) In an emergency situation, one (1) Sailor's draw per pay period of up to 50 percent gross straight-time wages earned at the time of the draw, not to exceed one thousand dollars (\$1,000.00) may be approved by Alaska Marine Highway System personnel staff with proper verification. An approved draw may be issued by a Purser on a vessel or by Juneau Central Office, Alaska Marine Highway System.

17.04 An employee's vacation and sick leave will be totaled on the employee's time sheet copy at least once every quarter.

17.05 Premium pay shall not be paid in addition to any premium pay (pyramiding of premium pay is prohibited).

17.06 An employee who establishes eligibility for vacation under Rule 23.01(B), will seven (7) years after establishing such eligibility, begin receiving an annual lump sum payment equal to eighty-four (84) times that employee's straight-time hourly rate.

17.07 In the event that work performed places the employee in one (1) or more classifications when so directed by the Employer, the Employer agrees to pay such employee according to the highest-rated classification worked, provided that when the employee works more than one-half (1/2) of their regular workday at the higher-rated classification at the direction of the Employer, they shall be paid at

the higher pay rate for the entire workday. When an employee is requested to work in a lower wage rate due to a temporary fluctuation in work, the employee's regular rate shall be paid for all such lower-rated work performed.

17.08 - Pay Problems

Any dispute by an employee alleging an error in their paycheck shall be brought to the attention of the Employer on employee "Notice of Pay Problem" forms within thirty (30) calendar days from the end of the pay period in which the dispute arises. It shall be the employee's responsibility to complete the form with full details of the complaint and to insure that the Union receives a copy of the "Notice of Pay Problem." The Employer shall respond within fifteen (15) working days from the Employer's receipt of the "Notice of Pay Problem." A copy of the response shall be sent to the Union. However, should the response not be satisfactory to the employee and the Union, a grievance may be entered at Step One under Rule 14.02 within fifteen (15) calendar days after the "Notice of Pay Problem" response is due or received, whichever is earlier.

17.09 - Lost Wages

If an employee is not dispatched in accordance with the seniority provisions of Rule 26 and the dispatch provisions of Rule 27, the employee is due the difference in wages of the higher classification and the wages the employee earned during that assignment, or if not dispatched the wages that would have been earned, except where lost wages are specifically excluded.

RULE 18 - HOURS -- VESSEL ON THE RUN

18.01 Twelve (12) hours shall constitute a day's work for watchstanders and nonwatchstanders. The daily hours for watchstanders shall be divided into sea watches of six (6) hours on duty followed by six (6) hours off duty.

18.02 - Day Crew Members -- Twelve (12) Hours

Twelve (12) consecutive hours shall constitute a day's work, except steward's department employees who may work twelve (12) hours a day broken into any three (3) work shifts with a minimum break of two (2) hours between shifts with a minimum of one (1) six (6) hour break during a twenty-four (24) hour work period. Days on duty and days off duty shall be the same as for the watchstanding crew members. On the last day of the seven (7) day workweek, the Chief Steward shall post a schedule for the crew's next workweek detailing hours on duty and off duty for each position.

18.03 Inport Extras may be used to do any additional on-board work in their classification as defined by the Employer while the vessel is in revenue service and is in port.

RULE 19 - MONTHLY WORK

19.01 Two (2) complete crews shall be assigned to each vessel with the workdays divided evenly during each year between the two (2) crews as nearly as practicable. Each crew will work one (1) week (seven [7] consecutive days) followed by one (1) week off duty with the alternate crew relieving. The provisions of this Rule shall not apply to shipyard, lay-up or tie-up time.

19.02 - Two Week Work Tours

The parties agree to allow employees the option of a two week on/two week off schedule subject to the following guidelines:

(A) Employees working opposite, on different crews, must mutually agree on the work schedule and receive approval from the General Manager of AMHS or designee.

(B) If one of the Regularly Assigned Employees is unable to meet the assignment agreement (vacation, sick leave, etc.) the most senior relief will be offered the position with a choice of either one or two week assignment.

(C) There shall be no additional cost to the State directly related to this option.

(D) Unearned wages, payable under Rule 9, will be limited to 84 hours.

RULE 20 - EMERGENCY SERVICE

Emergency service such as collision, breakdown, standing to and rendering aid to another vessel or parties in distress shall not be considered overtime. The additional hours shall be paid for only at the straight-time rate. Any late arrival at crew change ports due to such emergency service is included and the straight-time rate, to the extent of the emergency service rendered as indicated in the ship's log, shall be paid to those crew members held over on duty. Breakdown shall be defined as rendering vessel dead in the water or loss of main propulsion. Emergency service shall continue only until vessels are in safe moorage at a dock or safe anchorage where the emergency repairs, minimally needed for safe operation, are to be affected.

RULE 21 - LATE ARRIVAL

21.01 When a vessel is delayed for any reason other than "Emergency Service" in excess of one (1) hour after scheduled time of crew change at change ports, such delay shall be termed a "Late Arrival." Scheduled time of crew change shall be determined by the port captain's memo listing scheduled crew change times and verified by dispatch's weekly crew change memos. The hours involved in such delays shall be determined by the Deck Log. Total hours shall be calculated from the scheduled crew change times. If at the time the Crew List is posted on Friday, a schedule change is implemented that calls for a longer workweek than originally scheduled, Late Arrival will not apply.

21.02 Personnel scheduled to be relieved at their change port will be paid overtime rate of pay for that portion of the Late Arrival period that they are on duty and straight-time for that period that they are off duty with the following limitations:

(A) Twelve (12) hours pay of either scale or combination thereof shall constitute a day's pay.

(B) Nonwatchstanders shall be paid for the delay one-half (1/2) at straight-time and one-half (1/2) at overtime, unless proof of time actually worked is in excess of one-half (1/2) the delay period. In that case, the overtime will apply to the time worked.

(C) The foregoing applies to delays of twelve (12) hours or less. Delays over twelve (12) hours will be handled under regular call back or overtime rules for the entire Late Arrival.

21.03 – Early Crew Change

When circumstances, other than a schedule change or a change in change ports, necessitate an early crew change, and the change is made twelve (12) or less hours early the provisions of Rule 21.02 will apply. If the change is made more than twelve (12) hours early, Rule 22.02 will apply.

RULE 22 – OVERTIME

22.01 - Overtime

(A) When a crew member is called back to work in advance of regular straight-time and overtime is extended into straight-time, or is required to work beyond normal straight-time and straight-time is extended into overtime, the minimum overtime payment shall be one (1) hour.

(B) When crew members are released from duty having completed their regular watch and are called back to work and are released before their next watch commences, the minimum overtime payment shall be two (2) hours. Overtime payments in excess of the minimums provided for in this Agreement shall be computed as provided above.

(C) When crew members are on overtime and are released from duty with less than one (1) hour prior to going on watch at straight-time, time shall run continuously. If crew members are called back to duty and released within one hour of completing their regular watch, this will be considered a one hour hold-over.

(D) Off watch overtime shall commence when a crew member is called out and the crew member shall be called at least thirty (30) minutes before work commences. When the deck crew is called out for mooring of the vessel, the actual time crew is called shall be entered in the ship's log for use in compiling proper time sheet entries. Crew shall remain on call-out status until released by the Master after line stowage and secured for sea.

(E) There shall be no overtime payments for work of ten (10) minutes or less beyond minimum call-out time.

22.02 When a Regularly Assigned Employee has worked a regularly assigned week (seven [7] consecutive days) and is required to work during the assigned days off (seven [7] consecutive days) the employee shall be paid at the overtime rate of time and one-half (1-1/2) for the time worked, with a minimum of twelve (12) hours at the overtime rate for the day in which the employee reports to work. When an employee is required to work on their week off due to a schedule change or change in change ports, the twelve (12) hour minimum will not apply and the employee will receive the standard six (6) hours of pay at the overtime rate for the day in which the employee reports to work. When an employee is assigned to a permanent upgrade position, this Rule shall not apply for the first consecutive seven (7) day period.

22.03 - Work in Excess of Eighty-Four Hours Per Assignment

(A) Twelve (12) hours shall constitute a day's pay. Time worked in excess of twelve (12) shall be paid at one and one-half the employee's straight-time rate of pay.

(B) Eighty-four (84) hours shall constitute a normal assignment for all employees other than those dispatched as Extras or in accordance with Rule 25.01(D). All employees shall be paid for time worked in excess of eighty-four hours at one and one-half the employees straight-time rate of pay in fifteen (15) minute increments.

(C) A Regularly Assigned Employee's "normal" change day shall be the eighth calendar day after they are relieved. For example, if an employee was relieved on Friday, their change day would be the following Friday.

(D) If a Regularly Assigned Employee returns to work prior to their calendar change day as described in (C), above, the RAE will be paid at one and one-half the employee's straight-time rate of pay for six (6) hours on the day they report to work. The RAE will continue to be paid at one and one-half of the employee's straight-time rate of pay for actual time worked until their —normal|| calendar crew change day. On that day, the RAE shall be paid for six (6) hours at one and one-half the employee's straight-time rate of pay, and six (6) hours at the straight-time rate of pay.

(E) When an employee is on any crew bringing a vessel in or out of the yard, seetime will begin or end in accordance with Rule 16. Once the employee has completed eighty-four (84) hours of work in seetime status, they shall be paid at one and one-half their straight-time rate of pay for actual time worked, until relieved or seetime is broken.

(F) Employees working a two week on-two week off schedule shall receive overtime for any work in excess of one hundred and sixty-eight (168) hours.

22.04 - Computation and Assignment of Overtime

(A) There shall be no pyramiding of overtime.

(B) The employer agrees to attempt to equalize overtime between qualified employees within each department as operations permit.

RULE 23 – VACATION

23.01- Employees Hired On or After July 1, 2008.

The vacation accrual and eligibility for accrual for employees hired on or after July 1, 2008, shall be in accordance with 23.01 (A) and (B) below.

(A) Accrual Rates. Vacation shall accrue according to the following schedule:

<u>Years of Continuous Service</u> <u>Hours Per Year</u>	<u>Vacation Accrual</u>
0 but less than 2	84.0
2 but less than 3	168.0
3 but less than 4	252.0
4 but less than 5	336.0

(B) Eligibility for Accrual. Eligibility for vacation shall commence once the employee has accumulated one thousand ninety-two (1,092) straight-time hours of compensation. The employee will then be considered as having six months of continuous service, and shall be credited with forty-two hours of vacation. Once the employee has accumulated two thousand one hundred and eighty four (2184) hours of straight time compensation they will then be considered as having established a leave anniversary date. Upon the establishment of a leave anniversary date, the employee shall be credited with the remaining forty-two (42) hours of vacation. Vacation in successive years shall be at rate shown in Rule 23.01(A).

23.02 - Employees Hired On or After April 1, 1985.

The vacation accrual and eligibility for accrual of employees hired on or after April 1, 1985, shall be in accordance with 23.02(A) and (B) below.

(A) Accrual Rates. Vacation credits shall accrue according to the following schedule:

<u>Years of Continuous Service</u> <u>Hours Per Year</u>	<u>Vacation Accrual</u>
1 but less than 2	84.0
2 but less than 3	168.0
3 but less than 4	252.0
4 but less than 5	336.0
5 or more	420.0

(B) Eligibility for Accrual. Eligibility for vacation accrual shall commence once the employee has accumulated two thousand one hundred eighty-four (2,184) straight-time hours of compensation. The employee will then be considered as having one (1) year of continuous service, thereby establishing a leave anniversary date. Upon the establishment of a leave anniversary date, the employee shall be credited with eighty-four (84) hours vacation. Vacation in successive years shall be at rate shown in Rule 23.02(A).

Vacation benefits awarded under this Rule will not be construed as establishing seniority, which is separately defined in Rule 26.

Once eligible for vacation accrual, an employee will be credited with one-thirteenth (1/13) of the year's vacation accrual during every month in which the employee is compensated for a minimum of eighty-four (84) straight-time hours. An employee's leave anniversary date will be adjusted forward one (1) month for each calendar month that the employee does not receive vacation credit.

23.03 - Employees Hired Prior to April 1, 1985

The vacation accrual and eligibility for accrual of employees hired prior to April 1, 1985, shall be in accordance with 23.03(A) and (B) below.

(A) Accrual Rates. Vacation credits shall accrue according to the following schedule:

<u>Years of Continuous Service</u> <u>Hours Per Year</u>	<u>Vacation Accrual</u>
1 but less than 2	84.0
2 but less than 3	168.0
3 but less than 4	252.0
4 but less than 5	336.0
5 but less than 7	420.0
7 but less than 10	504.0
10 or more	588.0

(B) Eligibility for Accrual. Eligibility for vacation accrual shall commence once the employee has accumulated one thousand six hundred (1,600) straight-time hours of compensation within any twelve (12) month period from date of original hire. The employee will then be considered as having one (1) year of continuous service, thereby establishing a leave anniversary date. Upon the establishment of a leave anniversary date, the employee shall be credited with eighty-four (84) hours vacation accrual. Vacation in successive years shall be at rate shown in Rule 23.03(A).

Vacation benefits awarded under this Rule will not be construed as establishing seniority, which is separately defined in Rule 26.

Once eligible for vacation accrual, an employee will be credited with one-thirteenth (1/13) of the year's vacation accrual during every month in which the employee is compensated for a minimum of eighty-four (84) straight-time hours. An employee's

leave anniversary date will be adjusted forward one (1) month for each calendar month that the employee does not receive vacation credit.

(C) Employees covered by this section who have vacation balances of at least one hundred and sixty eight (168) hours, shall be permitted to cash out one hundred and sixty eight (168) hours of vacation once per calendar year with the approval of the Director of the Division of Labor Relations . The employee's vacation balance shall be reduced by the number of hours for which payment is made.

23.04 - Use of Vacation

(A) Vacation shall be taken at a time that is mutually agreeable to the Employer and the crew member. All vacations and leaves of absence must be approved by the Employer in advance of their commencement. Such approval will not be unreasonably withheld.

(B) During periods of lay-up of vessels, crew members with greater amounts of vacation may be required, through joint agreement by the Labor/Management Relief Assignment Committee, to utilize this time in order to permit other members to remain working.

23.05 - Terminal Leave

In case of an employee terminating services at any time after the employee has established eligibility for vacation benefits, the employee shall receive cash payment for whatever vacation that employee has accrued.

23.06 - Vacation Pay Rate

Regularly Assigned Employees and RAREs shall be paid for vacation at the rate of their current bid job, employee's not holding permanent bid position will be paid at the rate of pay for the classification in which the majority of the employee's time was worked within the preceding year. Relief Employees shall receive the rate of the classification in which the majority of the employee's time was worked within the preceding twelve (12) months. Seasonal Employees shall be paid for vacation at the entry-level rate for the department in which the majority of the employee's time was worked within the preceding twelve (12) months. An employee who works and uses time off in the same month must use the same pay type (Southeast or Southwest) for time off.

Employees may use annual leave or A-days for an entire month, but may only combine annual leave and A-days in any one month when their annual leave or A-day account is depleted.

23.07 - Maximum Accumulation of Vacation

Vacation accrued but not used shall accumulate to a maximum of eight hundred and forty (840) hours on June 30 of any calendar year. If an employee has, as of June 30, an amount of vacation in excess of eight hundred and forty (840) hours, the excess shall be deducted from the employee's vacation balance. However, if circumstances cause the Employer to refuse an employee's timely request for vacation, the amount of vacation refused will be carried over.

23.08 - Union Business Leave

(A) Members shall have six (6) hours of vacation contributed to the Union Business Leave Bank on an annual basis. Contributions shall take place annually on or about August 1. Such vacation shall be converted to dollars at the hourly rate of the donor and transferred to the Union Business Leave Bank.

Withdrawal requests from the Bank will be for purposes of contract negotiations, executive meetings, training sponsored by the Union and other purposes as may be determined by the Regional Director. Requests for withdrawal from the Bank shall be made only by the Regional Director to the Director of the Division of Labor Relations on forms mutually agreed on by the parties and furnished by the Union. All vacation transferred to the Bank is final and not recoverable for recredit to an individual's vacation account. If the Union believes an improper contribution has been made to the business leave bank the Regional Director must request correction within thirty (30) days of the contribution or from becoming aware of the improper contribution.

Once the Bank has reached an accumulation of one hundred and ten thousand, five hundred dollars (\$110,500.00), contributions shall cease and will be reinstated only when the cash value in the Business Leave Bank drops below forty-two thousand, five hundred dollars (\$42,500.00). The Union shall be responsible for monitoring the balance in the Union Business Leave Bank and will notify the AMHS when the ceiling and floor dollar amounts are met.

(B) Employees shall be allowed to voluntarily donate vacation to the Union Business Leave Bank, subject to the following procedures and conditions:

- (1) Each employee wishing to donate vacation will fill out, date and sign a vacation request showing the amount of vacation to be donated.
- (2) Each such vacation request will have written or typed along the bottom, "Vacation donation to Inlandboatmen's Union of the Pacific, Alaska Region, Union Business Leave Bank."
- (3) Inlandboatmen's Union of the Pacific, Alaska Region, will deliver all such vacation requests to the Alaska Marine Highway System. The vacation hours shall then be converted to dollars at the hourly rate of the donor and be transferred to the Union Business Leave Bank.
- (4) The Employer will not be responsible for the collection, or any statements made in relation to the collection, of said donations.
- (5) All donations are final and not recoverable for recredit to the donor's account.
- (6) It is understood that such voluntary vacation donations are in addition to the mandatory vacation donation of one (1) day required under Rule 23.07(A).

(C) The release of members from duty for Union Business Leave shall be handled on the same basis as release for vacation. Approval for such release shall not be unreasonably withheld by the Employer.

23.09 - Court Leave

(A) An employee who is called to serve as a juror or is subpoenaed as a witness shall be entitled to court leave provided that they would have been working aboard a vessel of the Alaska Marine Highway System. Employees must notify the personnel section in writing within ten (10) days of receipt of notice and prior to jury service in order to be eligible to use court leave. Court leave shall be in the form of straight-time pay for the hours of work missed due to service as a juror or witness at the pay rate that would be appropriate if the employee were on annual leave. To receive pay for court leave, the employee must turn over to the Alaska Marine Highway System all monies received from the court as compensation for service as a juror, or any monies received as compensation for service as a witness. Claims for court leave must be supported by written documents such as a subpoena, Marshall's statement of attendance and compensation for service, per diem and travel.

(B) Employees will only receive court leave pay from the AMHS for the actual time that they are physically unable to work because they either have not been excused or have been selected and physically served on a jury or as a witness. In all cases, the individual must present proper documentation in accordance with Rule 23. In order to assure pay during the time involved with court duty, employees should submit a request for annual leave for the affected pay period(s) and accrual balance adjustments will be made when the verification documents are given to the personnel section of the AMHS. In all cases, the individual must present proper documentation in accordance with Rule 23.

Seniority shall accrue while the employee is on paid court leave for the time absent from work provided the employee was eligible for dispatch based on their seniority.

(C) Jury Pool Leave:

Upon receipt of notification of the employees selection to the jury pool , and where daily call-ins are required, the employee must notify the personnel section in writing immediately upon notification. If scheduled work assignments conflict with the notification to serve on the jury pool, the employee must make a request to the clerk of the court to exempt the employee for scheduled days of work. If an employee's request is denied then the employee will be placed on court leave for the amount of hours sufficient to comply with the provisions of Rule 25. The employee must provide written documentation from the clerk of the court in order to receive court leave.

23.10 - Other Approved Leave

Upon application and approval of the appointing authority, an employee may be granted leave without pay. Such leave shall not normally exceed six (6) months. Said leaves of absences shall not be unreasonably denied.

The employee's seniority held at the time of leaving active service shall remain static except as provided for in Rule 26. Leave without pay time shall not be used when computing continuous service for benefit purposes.

23.11 - Leave Donations

Members of this bargaining unit shall be allowed to donate annual leave to and receive donations of annual or personal leave from employees in this unit or those represented by a different union or non-covered employees subject to the following provisions:

(A) Each employee wishing to donate annual/personal leave will fill out, date and sign a leave slip showing the amount of leave to be donated subject to a minimum of four hours. The leave slip will have written along the bottom, or in the space provided, "Leave donated to (employee name, Employee Identification Number)."

(B) The recipient's union will be responsible for gathering all leave donations to be forwarded to the Technical Services Section to the recipient's account during the pay period in which received (1 through 15, or 16 through the end of the month) for use from that pay period forward. Donations shall not be posted for use in a pay period prior to that in which received.

(C) The Technical Services Section will convert the donated leave to dollars at the annualized hourly rate of the donor. That dollar amount will be converted to leave at the annualized hourly rate of the recipient and the appropriate hours of leave will be added to the recipient's donated leave account for use as sick leave. The total amount of leave credited to the recipient's donated leave account from one individual shall not exceed one hundred sixty eight (168) Southeast hours or two hundred and forty (240) Southwest hours during the life of the current agreement. Donated leave may not be used until all accrued sick and annual leave has been exhausted.

(D) Once the Technical Services Section has completed the above process, the State will not be obligated for further processing or liabilities resulting there from. Once the donation has been transferred to the recipient, the donation cannot be withdrawn, modified or otherwise returned to the donor's leave account.

23.12 - Requesting Vacation

Requests for vacation must be received by the Crew Scheduling Office not later than sixty (60) days prior to the commencement of the four week work schedule for which the leave is requested. Crew Scheduling will approve or deny leave requests (30) days prior to the commencement of the four week work schedule. Employees in the Southeast System may be granted up to two (2) weeks of vacation during the period June through September. If a request for vacation dates conflict, seniority shall apply. Requests for leave in periods other than detailed above shall be granted at the discretion of the Employer.

RULE 24 – HOLIDAYS

24.01 The following holidays shall be recognized holidays: New Year's Day, Martin Luther King, Jr. Day, Lincoln's Birthday, President's Day, Seward's Day, Memorial Day, Independence Day, Labor Day, Alaska Day, Veterans Day, Thanksgiving and Christmas Day, or other days as may be declared as legal holidays by the Governor of Alaska.

24.02 All employees in pay status shall receive twelve (12) hours at the appropriate straight-time base rate of pay for each holiday listed in Rule 24.01. Employees shall be paid for holidays at the rate of pay for the classification in which they are assigned at the time of the holiday.

24.03 Employees assigned to a ship in the yard or lay-up shall receive twelve (12) hours at the appropriate straight-time base rate of pay for each holiday listed in Rule 24.01.

24.04 Employees required to work on a holiday will be paid at the overtime rate of pay for actual hours worked. This pay will be in addition to the straight-time pay in Rule 24.02 and 24.03. Actual hours worked on a holiday will be credited towards an employee's minimum guarantee. Actual hours of work on a crew change day will be considered to be six (6) hours.

24.05 An employee shall be considered in pay status for the purpose of holiday pay when said employee is in pay status within seven (7) days of the holiday. The employee shall receive twelve (12) hours of holiday pay at the straight time rate of their current bid job. Employees, not holding a permanent bid position, shall be paid for holidays at the rate of pay for the classification in which the majority of the employee's time was worked within the preceding year. For the purposes of this Rule an employee must have been hired prior to the holiday and must not have terminated before the holiday.

24.06 - Observance of Holidays

A designated holiday will normally be observed on the calendar day on which it falls. Crewmembers working in more than one bargaining unit during a workweek in which a holiday falls will only receive holiday pay and/or holiday overtime pay once for each holiday.

RULE 25 - MINIMUM GUARANTEE

25.01 (A) All Regularly Assigned Employees shall receive in wages not less than eighty-four (84) times the employee's basic straight-time rate for each bi-weekly pay period. Minimum guarantee will not apply if the employee only works the first day of the pay period when entering or leaving a yard.

(B) All Relief Employees, RAREs and DRAEs shall receive in wages not less than eighty-four (84) hours straight-time pay for each assignment.

(C) Holiday Premium Pay, overtime worked beyond the basic straight-time day and the premium portion of overtime shall be paid in addition to the guarantee.

(D) The above shall not apply to crew members engaged as seasonals or extras to relieve crew members for vacations, illness or leaves of absence.

25.02 - Show-Up Pay

When a relief is dispatched and reports to a job, but is not put to work, they shall be guaranteed a minimum of a full day's pay (twelve [12] hours) for the assignment.

25.03 Employees dispatched for a full workweek shall be paid for six (6) hours of work on the first and last day of the assignment.

25.04 Employees dispatched for less than a full workweek shall be paid for actual hours of work on the first and last day of the assignment, but not less than six (6) hours.

25.05 Inport Extras will be paid a minimum of three (3) hours for each assignment. Any time worked in excess of twelve (12) hours in a twenty-four (24) hour period will be paid at the overtime rate rounded up to the next fifteen minute increment.

RULE 26 – SENIORITY

26.01 The Employer recognizes the principle of seniority in the administration of promotions, transfers, layoffs and recalls. Employees' seniority rights shall be applied to the award of bids in accordance with Rule 28, and shall be applied to dispatch and job assignment in accordance with Rule 27.

26.02 Seniority is the total length of service with the Employer in any classification covered by this Agreement, and shall begin with the first day of work with the Employer. Seniority shall be cumulative utilizing the formula of one (1) point for each odd numbered bi-weekly pay period. One (1) seniority point equals two (2) pay periods. There are three (3) categories of seniority -- job seniority, department seniority, and company seniority.

26.03 In computing seniority, a seniority point shall be earned at the end of the seniority calculation period in which the employee is in pay status for a minimum of eighty-four (84) straight-time hours. Earned seniority points are not available for use until the next scheduling period.

Employees in non-pay status will not accrue seniority points. A workweek that commences in one (1) seniority calculation period and ends in another shall be credited to the seniority calculation period in which the workweek began, unless the employee has been in pay status for eighty-four (84) straight-time hours before the end of the seniority calculation period in which the assignment began. If the eighty-four (84) hour minimum has already been filled, the hours in pay status in the following calculation period shall be credited to that calculation period for the purpose of computing seniority.

(A) JOB SENIORITY Job seniority is the length of service in a bid job in a given classification, beginning with the administrative award date. If a Regularly Assigned or Regularly Assigned Relief Employee does not satisfactorily complete the probationary period in a bid job, the job seniority points accrued in the probationary period shall be converted to the employee's previous classification. If a Relief or Seasonal employee bids on a regularly assigned position and fails to satisfactorily complete the probationary period, any job seniority points accrued as a result of that bid shall be forfeited. Regularly Assigned Relief Employees (RAREs) shall accrue job seniority in the designated classification.

When an employee is awarded a bid job, job seniority in other departments shall be retained for one calendar year after the employee satisfactorily completes the probationary period. After that year, job seniority points in other departments shall be deleted without loss of department or company seniority.

(B) DEPARTMENT SENIORITY Department seniority is the length of service in a given department. Points for department seniority are established by the completion of eighty-four (84) straight-time hours in a department. Department seniority begins in the month in which the employee began the eighty-four (84) straight-time hours.

If an employee works in more than one department in a seniority calculation period, the employee will be entitled to one department point for each department worked, provided the employee has worked at least eighty-four (84) hours in each department. A workweek that begins in one point calculation period and ends in another shall have the department point credited to the calculation period in which the workweek began.

Under no circumstances shall any employee receive more than one Company point, or more than one Department point in each department in any one seniority calculation period. Starting with the implementation of this contract, employees who start a workweek in one department and get transferred to another department during that workweek shall receive a department point for the department in which the most hours were worked that week.

(C) COMPANY SENIORITY Company seniority is the total length of service with the Employer in any classification covered by this Agreement and begins with the first day of work with the Employer. Points for company seniority are established by the completion of eighty-four (84) straight-time hours with the Employer.

26.04 Any employee who has established seniority and is selected to any full-time office in the Union shall continue to accrue seniority throughout either term or terms of office. Full time Offices of the Union shall include Regional Director, Patrolman, and Lobbyist. Vacation and sick leave balances will remain intact for the duration of their term of office, if they return to work with the Employer within ninety (90) days after leaving Union office.

If there is no bid opening in the employee's classification when the employee returns to work status following their term as Regional Director, Lobbyist or Patrolman, the employee shall return as a RARE and shall be dispatched in seniority order with other RAREs in that classification.

Any employee who is transferred to a position in Management shall continue to accrue seniority for twenty-four (24) months, after which their seniority will be frozen for the duration of employment with Management.

26.05 Seniority shall be terminated and the Employer-employee relationship severed by the following conditions:

(A) Discharge for cause.

(B) Continuous layoff of nine (9) months duration.

(C) Resignation or separation from State service.

(D) Failure to return from leave of absence, upon expiration of Family and Medical Leave and/or Alaska Family Leave, vacation or seasonal layoff on agreed date, emergencies excepted, unless otherwise mutually agreed upon by both the Union and the Employer.

26.06 (A) Employees may be granted leaves of absence up to six (6) continuous months in any year without loss of seniority. Retention of seniority during a longer leave of absence may be arranged for by agreement between the Employer and the Union. The six (6) month limitation shall not apply to disability cases or to schooling to upgrade in the Maritime Industry. Time involved during each leave of absence shall not be accumulative in regards to total seniority time. Seniority credit held at time of leaving active service will remain static until return to active service. Therefore, leave of absence time shall not be used when computing continuous service for pass, vacation, sick leave or retirement benefits. The provisions of Rule 31 shall apply when an employee applies for Family Leave.

(B) Regularly Assigned Employees, Regularly Assigned Relief Employees, and Relief Employees will continue to accrue seniority, up to three (3) points, while in approved leave without pay status during reduction in force periods. Seasonal Employees may take leave without pay but will not accrue seniority; it shall remain static. Seniority points accrued in accordance with this provision shall not be used when computing continuous service for pass, vacation, sick leave or retirement benefits, and shall apply to the Bid System only.

26.07 (A) Seniority rosters shall be published quarterly reflecting job, department and company seniority points as of March, June, September and December. The Union offices and all ships shall be provided copies of the seniority roster.

(B) Within ten (10) working days of receipt of notification of error in seniority point calculation, the Employer shall act upon or dispute seniority adjustments or corrections that are submitted by the Union in writing to the General Manager, AMHS or designee. In any case no notification of error will be considered outside the previous two (2) years. The Employer shall not be liable for lost wage claims until after the correction has been agreed upon or the dispute has been settled.

The Employer shall be allowed fifteen (15) working days to implement any corrections.

(C) In application of seniority the Union shall administer and decide any dispute. Other disputes that arise involving the Employer shall be processed through the disputes procedure under Rule 14. An employee's dispute regarding seniority decisions made by the Union shall be resolved through the procedure set forth in the Union's Constitution and Bylaws.

RULE 27 – DISPATCH

The State and the Union agree to form a Labor Management Committee (LMC) under Rule 1.04 for the specific purpose of addressing non-cost dispatch process issues. Participation in the LMC by the Union shall be at no cost to the State.

27.01

(A) In the application of seniority under this Rule, if an employee has the necessary qualifications to perform in accordance with job requirements, seniority shall prevail. Work assignments will be scheduled on a four week basis.

(B) Once a four (4) week work schedule is posted, emergency or unscheduled vacancies will first be filled through onboard upgrades in accordance with Rule 27.01 (G). Any remaining vacancies shall be filled from the relief pool in accordance with department seniority.

(C) Time requirement for requesting personal leave shall be in accordance with Rule 23.

(D) Every effort will be made to include at least one Union representative to participate in the compilation of the first two work schedules implemented under this Agreement.

(E) If an employee has been unfit for duty and has not made contact with and/or submitted documentation to Dispatch by noon on the Friday before the posting of the next four week schedule, it will be assumed that the employee is still unfit and not be assigned for the following weeks. However, if a non-RAE employee submits a fit for duty after the crew lists are posted, they will first be used to fill unexpected vacancies then the employee will be assigned in the following schedule. If the employee has no personal leave hours available or the dates they were unfit do not coincide with the missed assignment they will be placed on the next to go list. In order to be placed on the next to go list in these situations the employee is responsible for notifying Dispatch that they either do not have personal leave hours or that the dates of their unfit status do not coincide with their missed assignment.

If an employee has been fit and becomes unfit after crew lists have been posted, it will be assumed that the employee will remain unfit for one assignment only and

will remain on the schedule and not be replaced unless the unfit for duty form reflects an unfit period exceeding the length of one assignment.

Once the schedules are posted (the Friday prior to the beginning of a four week schedule) the only changes that will be made to those assigned position on the crew lists will be due to the filling of unexpected vacancies. If errors are discovered in dispatch procedures, such errors must be corrected by 4:30 p.m. without penalty.

Once schedules are posted, crewmembers will not be moved forward from assigned positions during the four week period to fill unexpected vacancies, even if the earlier vacancy is at a higher grade level or would give the employee more hours in the pay period. Rule 27.01 (G) still applies. No lost wages will be paid in this circumstance.

If an employee is offered a full assignment consistent with the choices on their Dispatch Selection Form, with less than twenty-four hours notice (last minute call) they can turn the position down without penalty and they will stay on the next to go list in the proper seniority order, even if the employee has had seven days off. If an employee is offered a full assignment consistent with the choices on their Dispatch Selection Form, with more than twenty-four hours notice (late call) and the employee has had seven days off, the employee must go to the assignment. If the employee refuses the assignment they will be —not necessarily dispatched|| for fourteen days.

In any event, if no employee accepts the assignment in the two paragraphs above, Dispatch will then rework the next to go list in reverse seniority order. Employees on the next to go list that refuse the assignment consistent with their choices on their Dispatch Selection Form, will be “not necessarily dispatched” for fourteen days, even if it is a last minute call. Employee that are “not necessarily dispatched” may be contacted and offered another assignment during the fourteen day period, but may refuse with no additional penalty.

(1) Steward Department

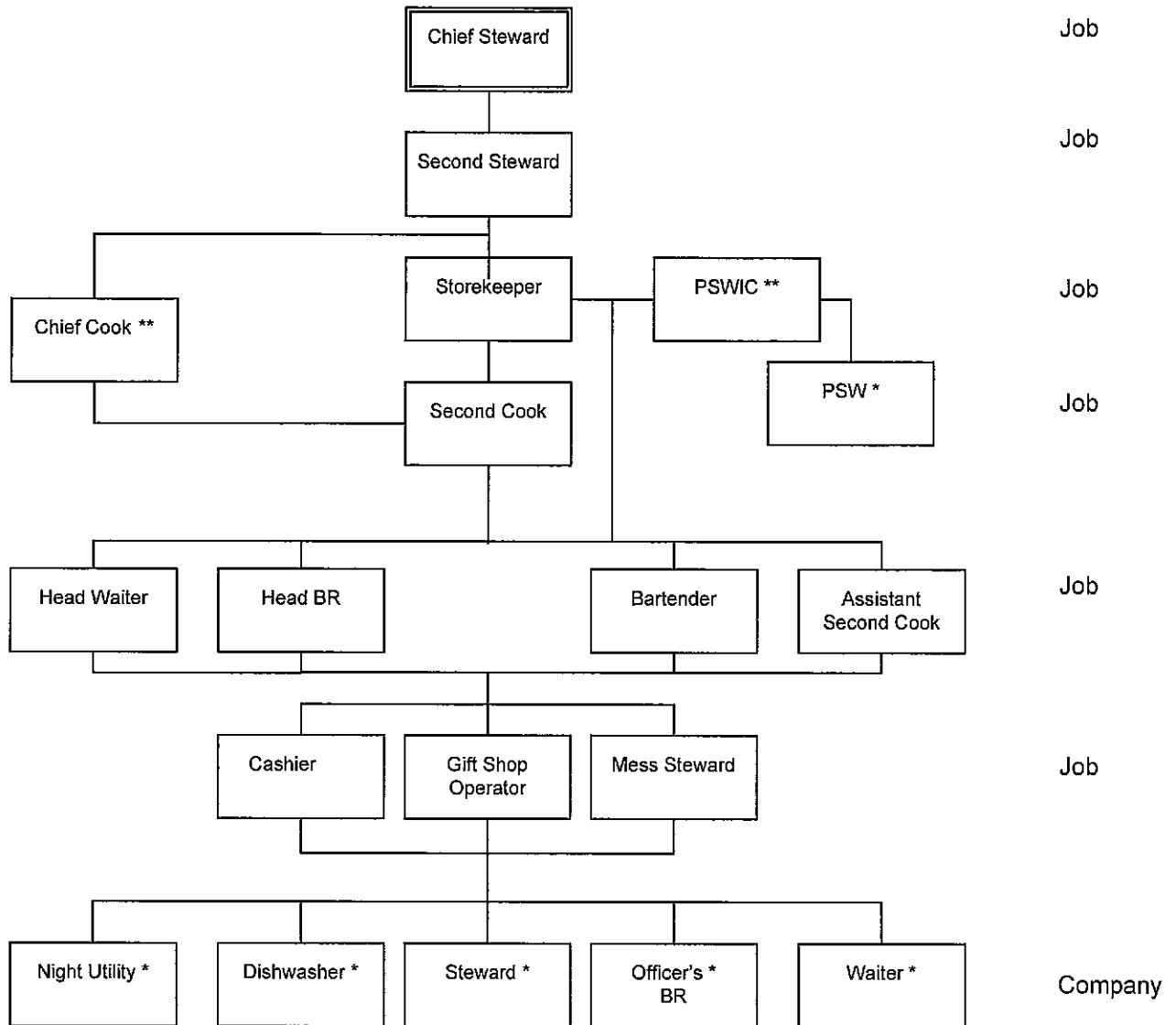

* Entry Level Position

** Employees advancing to RARE Storekeeper and above without previous assignment to Chief Cook or Second Cook shall not be dispatched to Chief or Second Cook during RIF.

(2) Purser Department

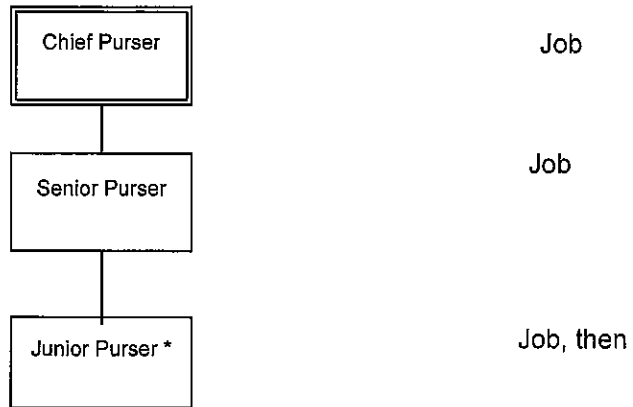

* Entry Level Position for dispatch during RIF

(3) Engine Department

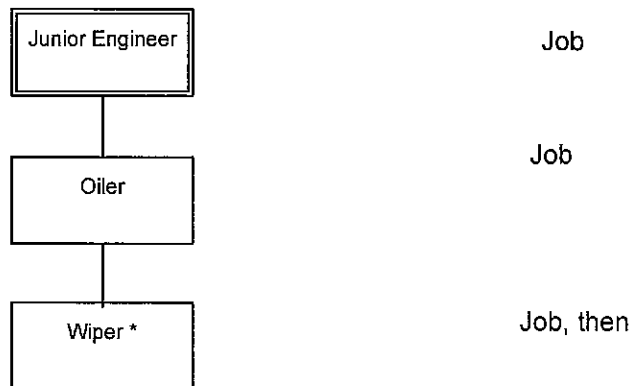

* Entry Level Position for dispatch during RIF

(4) Deck Department

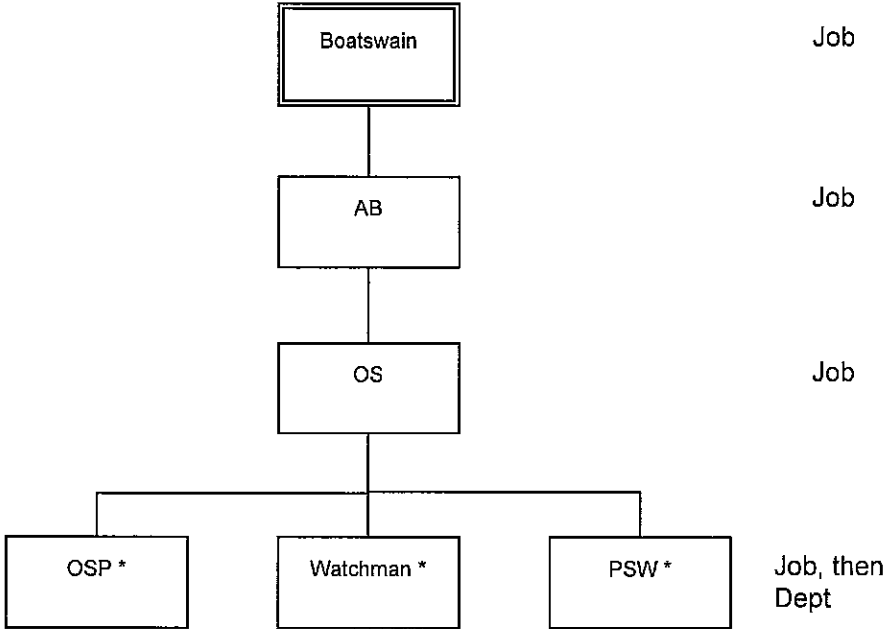

* Entry Level Position for dispatch during RIF

(F) RELIEF ASSIGNMENTS Rosters of employees interested in entry-level relief assignments to departments other than the steward's department, shall be maintained by department seniority. When dispatching entry-level relief assignments to departments other than the steward's department, first consideration shall be given to the employee with the most department seniority in the department in which the assignment is available. If an employee refuses a relief assignment in one (1) department in order to be dispatched to one (1) or two (2) of the other departments, then that employee's seniority in the department to which dispatch has been requested shall be substituted for that employee's company seniority for purposes of determining order of dispatch.

(G) TEMPORARY UPGRADES ONBOARD THE VESSEL The shipboard supervisor will recognize seniority in filling above entry-level relief assignments to promote upward mobility and the training of employees. Therefore, whenever possible, an above entry-level relief assignment shall be filled by temporary upgrade of a Regularly Assigned Employee on the vessel in the next lower classification in the applicable line of progression. However, if qualified Regularly Assigned Employees in above-entry level positions are not available for upgrade and the relief assignment will therefore be given to an entry-level employee, the assignment will be made based on department seniority.

(H) REDUCTIONS IN FORCE

(1) In the event there is a reduction in the working force which results in reassignment, employees shall be reassigned on a job seniority basis in the reverse order of their prior assignment. Employees assigned in this manner shall receive the applicable pay rate for the position to which assigned. In the event employees do not have sufficient job or department seniority to retain a position other than Steward, company seniority shall prevail in order to establish assignment in a Steward position.

(2) The following shall apply for the administration of seniority rights during reduction-in-force periods:

(a) Displaced Regularly Assigned Employees shall accept available relief assignments within their job classification provided no assignment is available in Rule 16.09.

(b) If no assignment is available within their job classification they will temporarily displace the most junior employee in the respective classification.

(c) Regularly Assigned Employees who refuse a yard assignment on their vessel will not be afforded bumping rights to any classification. Refusal of such assignments will result in the Regularly Assigned Employee being added to the relief pool and dispatches will be made on the basis of job seniority.

(d) Displaced Regularly Assigned Employees working in the Southeast System shall not normally be expected to have to temporarily displace junior employees within the Southwest System. The same applies for DRAEs working the Southwest System.

(I) RETURN TO SERVICE When employees are called back to service, the last laid off shall be the first restored to work. Employees who have been laid off shall keep

the Employer informed of their whereabouts in order to remain available for reassignment.

RULE 28 - BID AWARDS

28.01 Bid Jobs are regularly assigned positions on board a particular vessel and crew. Bid job vacancies shall be posted on board each vessel and at terminals for a period of not less than thirty (30) days. Relief personnel may be assigned to fill vacancies until the vacancy is filled through the bid award process. Vacancy advertisements will be posted and applications processed in accordance with the provisions set out in Rule 28.

28.02

(A) In the application of seniority under this Rule, if an employee has the necessary qualifications to perform in accordance with job requirements, seniority shall prevail. In awarding of bids an employee's personnel file will be subject to review.

(B) Pursuant to the parties' recognition of the principle of Affirmative Action, a bid to be awarded in a classification where underutilization has been found to exist may be awarded to the senior qualified bidder who is a member of the underutilized group. Any unsuccessful bidder shall have appeal rights under Rule 14.

(C) Transfer and Lateral: Employees will be required to work a bid position for a minimum of six (6) months before they are eligible to bid a transfer or lateral vacancy. This applies only to positions acquired by lateral or transfer.

Upgrades or Downgrades: Employees who are awarded a bid that results in an upgrade or a downgrade will be eligible to transfer or lateral to another job in the same classification one (1) time during the first six (6) months.

Employees who rescind a bid will be required to wait six (6) months prior to bidding on any other position in the same classification. In no case will an employee be allowed to lateral or transfer more than one (1) time in a six (6) month period.

28.03 Notwithstanding Rule 28.02(A), management retains the right to select and appoint employees in the following classifications: Chief Purser, Chief Steward, and Passenger Services Worker in Charge. Appointment to these classifications shall occur through the following process. The Employer shall post notice of job vacancies for Regularly Assigned and Regularly Assigned Relief bid openings for the above classifications aboard all AMHS vessels and terminals for a period of not less than thirty (30) days. In filling the vacancies for these classifications, the Employer will select an individual from the pool of applicants who is deemed qualified and competent to perform the duties of the position. Seniority will be considered.

28.04 - To Be Considered a Qualified Applicant

(A) Documented evidence that the employee meets the U.S. Coast Guard requirements must be on file at AMHS by the deadline for receiving bid applications.

(B) The employee must satisfy the minimum qualifications (MQs) as specified in the AMHS class specifications for the position bid. Information concerning job qualification standards for hiring and promotion shall be established for all positions and will be made available on all vessels and a copy to the Union when available.

28.05 – Lines of Progression for Purposes of Awarding Bids

(A) Steward Department

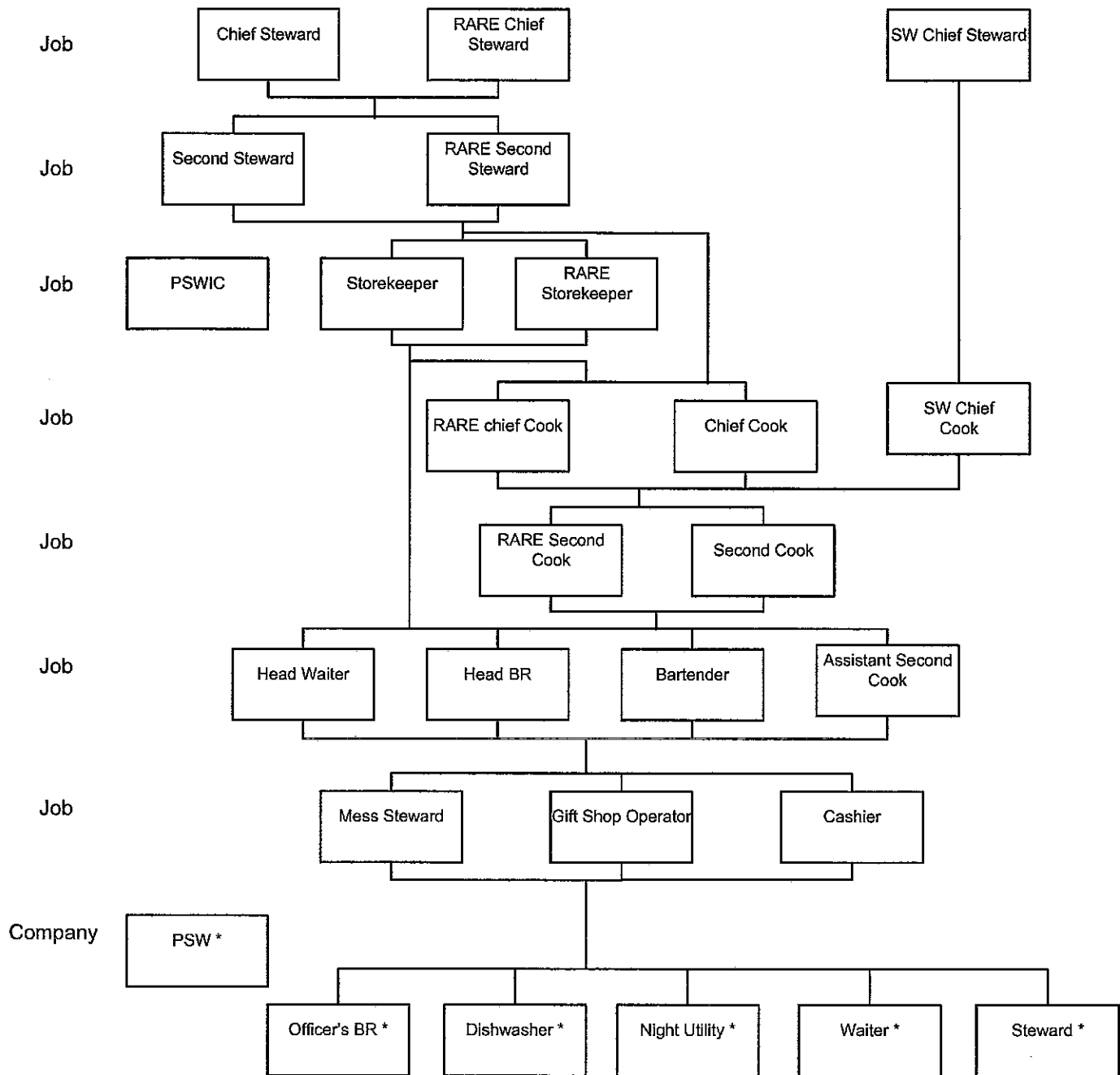

* Entry Level Position

** In addition to the provisions of Rule 28, a Southwest Chief Cook must have thirty-six working Southwest Chief Cook job points and meet all minimum qualifications (except those of the Storekeeper and Second Steward Classifications) to qualify as a Southwest Chief Steward applicant.

If a Southwest system Chief Steward with less than sixty (60) working job points as Southwest Chief Steward bids into the Southeast system, the Southwest Chief Steward job points will be converted to Chief Cook points. This Provisions applies only to Southwest Chief Stewards who upgraded to Chief Steward from Chief Cook.

*** Entry level, non-bid position

(B) Deck Department

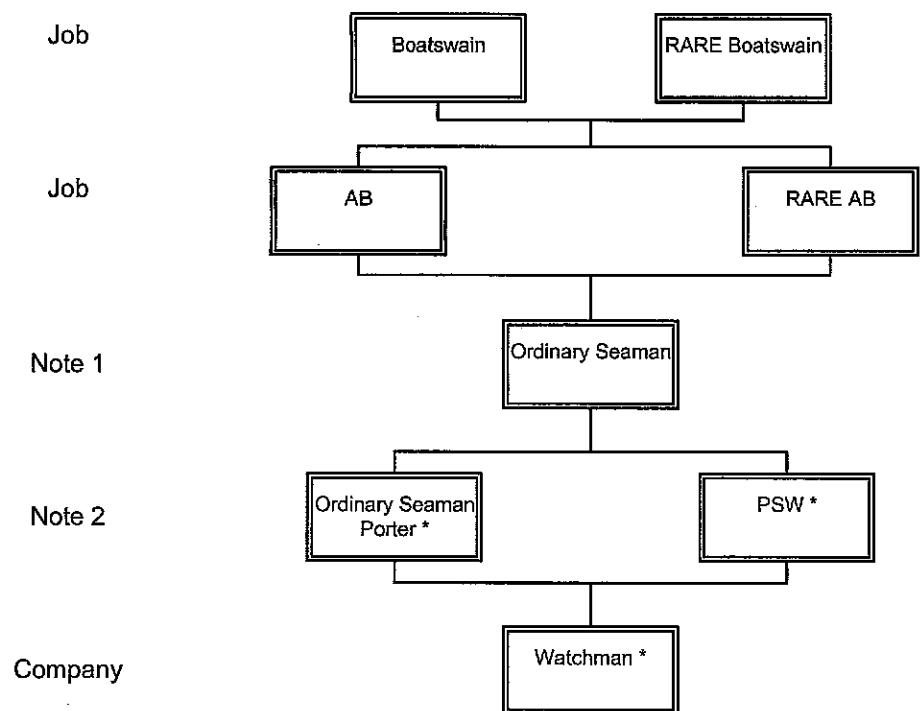

* Entry level position

Note 1: For Bid purposes, the OS job will be awarded to the most senior person in the next lower job classification (OSP or PSW, then Watchman). If no qualified OSP, PSW, or Watchmen bids on the OSP job, the job will be Awarded by Department Seniority. All other preferred actions will apply.

Note 2: For bid purposes, the OSP of PSW job will be awarded to the most senior person in the next lower job Classification (Watchman). If no classified Watchman bids on the OSP or PSW job, the job will be awarded by Company Seniority. All other preferred actions will apply.

(c) Purser Department

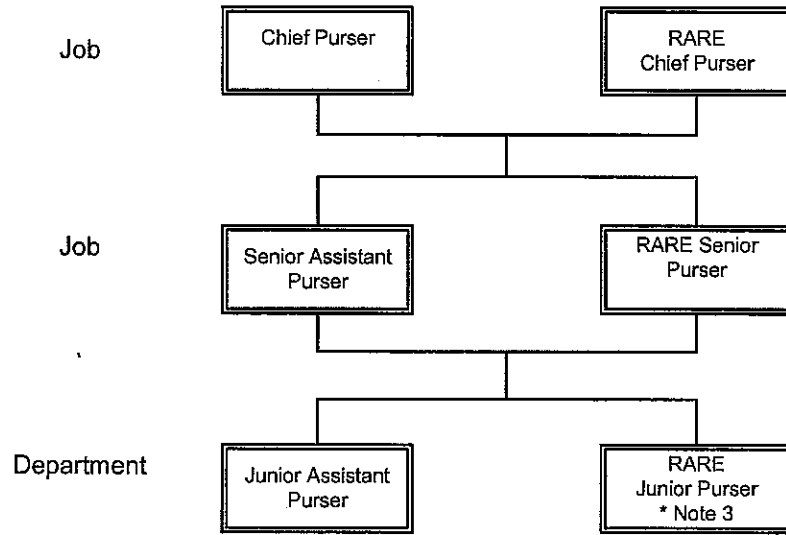

* Entry Level Position
 Note 3. Awarded by company Seniority

(d) Engine Department

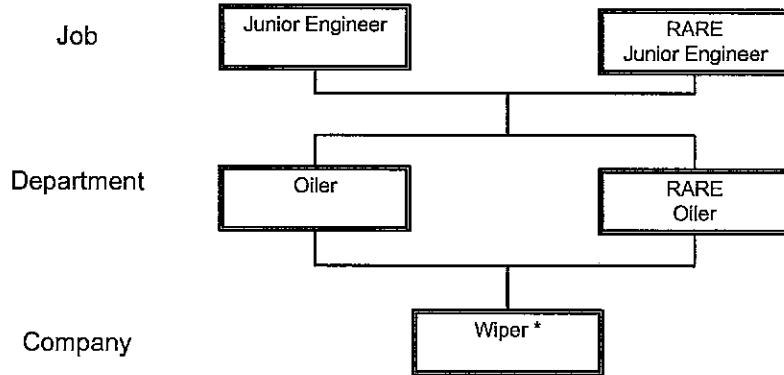

* Entry Level Position

28.06 - Preferred Actions

Bids that would accomplish the following actions shall be considered before bids that represent either promotions or entry-level interdepartmental transfers:

(A) Voluntary demotion of a Regularly Assigned Employee to a classification which is lower in the applicable line of progression.

(B) Transfer of a Regularly Assigned Employee or a Regularly Assigned Relief Employee (RARE) to a Regularly Assigned or Regularly Assigned Relief Employee (RARE) in the same classification; e.g., Junior Engineer to RARE Junior Engineer or visa versa and S/P TAKU A to S/P KEN B or HBR MAT A to HBR MAT B.

(C) Lateral movement of a Regularly Assigned Employee from a classification which is at the same level in the applicable line of progression as the classification being bid ("lateral bid"); e.g., Head BR to Bartender.

(D) Bids representing the foregoing actions will be considered in the same order as listed above. If no such bids are submitted, the bid will be awarded in accordance with the remaining provisions of this Rule. For purposes of taking the above preferred actions, Relief Employees with previously accrued job seniority in a classification shall be treated as Regularly Assigned Employees in the classifications in which they possess job seniority.

28.07 - Application of Seniority

(A) When there is more than one qualified applicant in a Preferred Action category, the bid award will be determined in job, department, and company seniority order.

(B) In awarding all other bids, where job seniority is equal, department seniority shall prevail. Should department seniority be equal, company seniority shall prevail.

28.08 - Entry Level Assignments

(A) Regularly Assigned Positions. In the event an employee in one (1) department bids an entry-level vacancy in another department, company seniority shall prevail and seniority shall not be interrupted.

(B) Entry-level steward's department positions will not be subject to the bid process except for the positions of Dishwasher, Officer's BR and Night Utility. Employees will enter the steward's department as entry-level reliefs and will move to identified Regularly Assigned Positions in the steward's department based on their steward's department seniority.

(C) Entry level jobs in all departments will be awarded by company seniority.

28.09 - Promotions

First consideration will be given to employees with the earliest Administrative Award Date and the most job seniority working in the next lower classification, except where otherwise provided by USCG regulations. In the event an open position is not bid by anyone with seniority in the next lower classification, the Employer will consider bids from employees in the next lower classification and so forth, in accordance with Rule 28.04, Lines of Progression. However, if this process results in considering only bids of entry-level employees, the position will be awarded based on department seniority. Should department seniority be equal, company seniority shall prevail.

For the purposes of awarding a designated "promotion only" vacancy, if an applicant has job seniority in the classification being awarded, job points in the higher classification shall be added to the applicant's job seniority points in the next lower classification.

Awarding a bid job to a Relief Employee with no job points will be considered a promotion.

28.10 - Probationary Period

In any bid assignment to a new job classification, employees shall have a six (6) month (but not less than thirteen (13) working assignments in the Southeast System) probationary period in the new position. Such probationary period shall be no less than one (1) month. The maximum probationary period for employees in the Southeast System shall be thirteen (13) eighty-four (84) hour assignments. If the employee does not perform satisfactorily at any time within the probationary period, they will be removed from the bid position and shall not be eligible for dispatch to the classification in which employee failed to complete the probationary period unless mutually agreed by the parties.

28.11 - Employees' Obligation to Work Their Bid Positions

Regularly Assigned Employees (RAEs) and Regularly Assigned Relief Employees (RAREs) who choose to work as Relief Employees (REs) will forfeit their Regularly Assigned Position or their Regularly Assigned Relief Position and said position shall be open for bid. No employee may hold more than one (1) bid position. This provision does not apply to employees working temporary assignments at the Employer's direction.

28.12 - Certain RARE Assignments

When a vacancy occurs and it is necessary to appoint a Regularly Assigned Relief Employee (RARE) in the classifications of Second Steward, Storekeeper, Chief Cook, Second Cook, A/B Bos'n, or Junior Engineer or when no eligible RARE bids on a vacant Regularly Assigned Position in one (1) of these classifications, the following procedure shall apply:

(A) Bids will be solicited by postings on each vessel and at terminals for a period of not less than thirty (30) days.

(B) Management shall review the bids received, and shall identify the four (4) most senior qualified candidates, unless the classification is one where under utilization

has been found to exist, in which case management shall identify an additional four (4) qualified candidates. These additional candidates shall be the most senior qualified members of the underutilized group who have submitted bids.

(C) Management shall rank the candidates identified from most to least qualified and shall select the successful candidate for this group.

28.13 Employees regularly assigned to positions being deleted shall temporarily be designated as RAREs in their classification, and shall be considered as RAREs until three (3) bid sheets have been processed with bidding opportunities in their classification. After three (3) such opportunities, if the temporary RARE has not been awarded a bid job, the temporary RARE shall become a relief employee.

28.14 - Bid Advertisements and Awards

(A) Vacancies and awards shall be posted on board vessels at the IBU Offices and at the Ketchikan Dispatch Office between the 1st and 5th of January, April, July and October. Listed vacancies shall include all jobs on all vessels not filled at the time of the posted vacancy list.

(B) Employees must qualify before submitting for job classifications they are interested in by filling out a Job Class Application Form and attaching all documents required by the Employer to meet Minimum Qualifications. Employees shall be notified by the Employer within thirty (30) days if their application is accepted. Acceptance of this application by the Employer verifies that the employee is qualified to apply for a specific job classification posted by the Employer during the open period listed in 28.14(A). Employees must qualify for specific job classifications before submitting a job preference form.

(C) Vacancies shall be posted for a minimum of thirty (30) days, during which time employees must have on file with the Employer an approved Job Class Application in order to submit a Job Preference Form for any open job in that classification. On this form employees shall list what jobs they are applying for, and in what order of preference (i.e., ship(s), crew(s), and change port(s)). The Job Preferences may be listed by PCN or name and vessel.

(D) On the closing date of the bid advertisement period, all applications submitted on a Job Preference Form and not withdrawn by the employee in writing by the closing date shall be considered final. After the closing date, employees may not withdraw their application. Bids shall be awarded by the provisions set out in Rule 28. Employees shall be required to work their awarded bid job as listed in Rule 28.02(C) or go Relief.

(E) The General Manager will notify the Regional Director of all vacancies that will not be available for bidding. Administrative Award Dates (AADs) shall be determined by the Union.

RULE 29 - HEALTH AND WELFARE

29.01 The Employer shall obtain and provide a group health insurance plan covering unlicensed vessel employees, their spouses and dependents. Such plan shall maintain the level of coverage in effect for this bargaining unit on the date of signing of this Agreement, until such a time as changes are made in the level of benefits for the Health Insurance Plan provided by the Employer pursuant to AS 39.30.090. The Commissioner of the Department of Administration shall have the sole authority to determine the benefits provided by the Health Insurance Plan provided pursuant to AS 39.30.090.

The Employer shall provide written notice to the Union of changes to the Health Insurance benefits or premiums at least sixty (60) days prior to implementation. The Union may then 1) elect the Employer provided Health Insurance Plan pursuant to AS 39.30.090 or 2) provide coverage by participation in the IBU National's Taft-Hartley regulated health insurance trust –Inlandboatmen's National Health Benefit Trust|| to the bargaining unit members as provided at 29.02.

If the Union elects to accept the Employer provided Health Insurance Plan, the Union will not dispute the benefits offered by the State for any plan year of the Employer provided plan; provided no changes are made in the Employer provided Health Insurance Plan during that plan year.

29.02

(A) As an alternative to the Employer provided Health Insurance Plan as described in Rule 29.01, the Union may elect to provide its own health insurance program for its members. At any time, but not less than sixty (60) days prior to the rate change date, the Union shall notify the Employer in writing of its desire to cease the Employer provided health insurance coverage and its intent to establish a health care trust for its members in accordance with applicable laws and regulations.

(B) If the Union elects to provide a plan of its choice, conversion to a Union Health Trust shall be effective no earlier than July 1 of any year this agreement is in effect. If the Union elects to provide its own health insurance program, the Employer will remit to the Union the amount agreed to in 29.01, per month for each eligible employee.

(C) The parties agree that the Union will remain on the Employer provided Health Insurance Plan while the parties negotiate a Letter of Agreement for the Union Health Trust and until the effective date of the Union Health Trust pursuant to 29.02(B), or for a State Employee Health Trust.

29.03 The eligibility of employees and their dependents for each coverage referred to above and the precise benefits to be provided shall be as set forth in the insurance contract(s) entered into by the State of Alaska for that purpose.

Effective July 1, 2011, the Employer contribution shall be increased to one thousand two-hundred fifty dollars (\$1250) for each eligible employee per month. Effective July 1 of each of the following years of this agreement, the Employer contribution shall be the amount necessary to maintain coverage under the Select Benefits Default Plan.

Eligible employees shall pay by payroll deduction any difference between the employer contribution and the total premium required to provide the health care coverage for the employee, spouse and dependents.

Under no circumstances shall the State be responsible for the payment of any benefits under the health and welfare plan or plans administered by the Union or its agents, successors, or assignees. No disputes under or relating to such benefits shall be subject to the grievance arbitration procedure in the collective bargaining agreement except an allegation that the Employer failed to make the agreed upon contributions. The Union agrees and undertakes to assure that any alternative insurance plan or health and welfare plan implemented under this agreement is in compliance with all applicable Federal and State laws and regulations. The parties will meet and confer regarding changes in Federal or State laws and applicable regulations.

The State is not a party to, and has no obligations arising under such a plan. However, the State does recognize and acknowledge that the prompt and accurate payment of contributions is essential to the maintenance of the plan. The parties acknowledge that discrepancies between employee eligibility and corresponding contributions will frequently arise and may exist in any month. The parties will exercise all due diligence in reconciling contributions and eligibility on a monthly basis, including adjustments of overpayments and underpayments as may be necessary.

RULE 30 – PENSIONS

30.01 The employees shall enjoy the retirement benefits as outlined in the applicable statutes relating to the Public Employees' Retirement System (PERS). Benefit credits begin accruing October 1, 1983. Vesting credits only are accrued for service from October 1, 1978.

30.02 The parties agree that they will continue to participate in the Northwest Marine Retirement Trust for the sole purpose of permitting bargaining unit members with service prior to October 1, 1983, to vest under the NMRT. The Employer agrees to pay six dollars (\$6.00) per employee per year as the cost of maintaining such participation.

RULE 31 - SICK LEAVE

31.01 Employees with a minimum of six (6) months service shall accrue sick leave credit at the rate of fifteen (15) hours for each completed month of service.

(A) For employees hired prior to April 1, 1985, "six (6) months service" shall mean accrual of eight hundred (800) straight-time hours within any six (6) month period.

(B) For employees hired on or after April 1, 1985, "six (6) months service" shall mean accumulation of one thousand and ninety-two (1,092) straight-time hours.

31.02 Each crew member's sick leave balance is terminated on the same basis as seniority in accordance with Rule 26.05.

31.03 Sick leave may be claimed from the accumulated days of credit for any crew member for illness or injury that incapacitates the crew member to the extent that the employee is unable to perform assigned work. The employee shall notify the Employer of incapacitating illness or injury at the earliest possible time so that arrangements for a relief crew member may be made. Sick leave can be claimed for injury or illness that renders the employee unable to perform assigned work. If the injury or illness lasts more than three (3) days, the claim must be accompanied by a physician's certificate. Employees will not be required to provide a physician's certificate for illness of less than three days unless improper use is suspected. It is the employee's responsibility to notify the dispatch office of injury or illness. Failure to notify the dispatch office may result in disciplinary action.

31.04 Employees may use annual leave on interim days (to make whole) between scheduled crew change date and the date the employee becomes fit for duty. The sick leave relief employee shall not be entitled to minimum guarantee.

31.05 - Funeral Leave

Sick leave can be claimed for funeral attendance for deaths in the immediate family to the maximum of eighty-four (84) hours. "Immediate family" for the purpose of funeral leave, is defined as father, mother, step parents, persons standing in loco parentis, husband, wife, sons, daughters, step children, brothers, sisters, grandchildren, grandfather, grandmother, father-in-law and mother-in-law. It shall be the employee's responsibility to provide evidence of such attendance.

31.06 - Family Leave

The parties agree that the provisions of the Federal Family and Medical Leave Act (FMLA) and the Alaska Family Leave Act (AFLA) apply to bargaining unit members.

31.07 Accumulated unused sick leave will be paid to the beneficiary when death occurs prior to retirement.

31.08 No sick leave may be used in excess of that accrued as of the date leave commences. Upon return to work, leave accrued during the employee's absence becomes payable.

31.09 Sick leave may be claimed when there is illness within the employee's immediate family which requires the attendance of the employee at the direction of

a physician. Such absences shall in all instances be supported by a physician's certificate.

31.10

(A) Those individuals on leaves of absence taken in accordance with Rule 23.09 shall retain their sick leave balances in accordance with the following schedule:

- 0 - 3 years of leave--full sick leave balance
- 3 - 6 years of leave--75 percent of full sick leave balance
- 6 - 9 years of leave--50 percent of full sick leave balance
- 9 - 12 years of leave--25 percent of full sick leave balance
- 12 or more years of leave--0 percent of full sick leave balance

(B) In addition, the beneficiaries of those individuals on leaves of absences taken in accordance with Rule 26.06 will be paid the sick leave balance existing at the time of the employee's death, when death occurs prior to retirement.

RULE 32 - STANDARD DRESS

32.01 All of the unlicensed deck personnel will be required to wear standard dress while on duty. Standard dress will consist of dark blue shirts and trousers of "wash and wear" or similar type and navy blue jackets as required during the various seasons, and a regulation blue baseball cap displaying Alaska State Ferries insignia. Unlicensed deck personnel may wear a black watch cap outside or while working on deck.

32.02 All of the unlicensed engine room personnel will be required to wear a suitable and standardized blue boiler suit while on watch. The individual shall also provide and wear the baseball type cap with Alaska State Ferries insignia to be worn while in public spaces aboard. Unlicensed engine room personnel may wear a black watch cap outside or while working on deck.

32.03 Employees in the steward's or purser's department will provide themselves with black trousers/skirts, white shirts and black shoes. Galley personnel have the option of wearing standard checked cook's trousers.

32.04 Employees are to be neat and well groomed, their standard dress uniforms clean and worn at all times while on duty. Appropriate clothing must be worn whenever a crew member is in a public area and is off duty.

32.05 - Laundry and Uniform Allowances

In view of the above requirements, the laundry allowance shall be thirteen dollars and forty-six cents (\$13.46) per pay period for Chief Pursers, Senior Assistant Pursers, Junior Assistant Pursers, Chief Stewards and Second Stewards and/or other positions when required to wear the standard navy dress blue uniforms with internationally recognized insignia will be paid seventeen dollars and thirty-one cents (\$17.31) per pay period.

32.06 Laundry or uniform allowances are to be paid only if the required items are worn as stated. Union delegates shall assist in demanding such compliance. Recipients may be required to sign time sheets or other forms attesting to their eligibility to receive payment. Notwithstanding these conditions, there shall be no deduction from these allowances during periods of vacation, sick leave or accumulated time off.

32.07 Employees may display the Union's insignia on the working uniform in accordance with standards developed by the Employer and the Union.

32.08 AMHS may choose to provide uniforms and cleaning services to bargaining unit members in lieu of the laundry or uniform allowance in 32.05.

RULE 33 - PASS PRIVILEGES

33.01 Employees with twenty-four (24) points of company seniority as per Rule 26.03 will be issued annual passes upon request for the employee and spouse, subject to the following:

(A) The employee, employee's dependents and personally-owned vehicle shall be authorized free transportation on a space-available basis only. See Rule 33.07(A) for vehicle specification. Dependent children shall be eligible for pass privileges to age nineteen (19) years old or enrolled as a full-time student at an accredited university.

(B) The employee's vehicle shall not travel on a pass while the employee is on duty unless the vehicle is accompanying the employee's dependent(s). Employees on duty shall not transport other employees' vehicles on an annual pass.

(C) Two (2) personally owned vehicles may be listed and travel on an annual pass, but only one (1) vehicle may travel at a time.

(D) No pass shall be used for transporting goods for resale or for any purpose other than personal use.

(E) There shall be no excessive transport of a pass-listed vehicle nor joy-riding by dependents or the employee. Any contention or confirmation of a violation of this Rule will be made known to IBU at the earliest possible time. Should the Union fail to resolve the matter immediately, Rule 33.08 shall be initiated by the Employer.

33.02 Employees and/or their dependents traveling on passes will pay for all meals consumed. Meals will be taken in public dining areas and not in the crew mess. Any abuse will subject the involved employee(s) to possible discipline and loss of pass privileges.

33.03 Employees who retire from the Alaska Marine Highway System under provisions of PERS or the NMRT pension shall receive an annual pass for themselves, their spouse, dependents under nineteen (19) years of age, and for

their personally-owned vehicle. Dependents of deceased employees (whether retired or current) will continue to be eligible for pass privileges. Only one (1) vehicle per employee will be allowed a retirement pass. A retired employee's vehicle must be registered and licensed appropriately.

33.04

(A) All employees who have established seniority with the company will be entitled to trip pass privileges. Trip passes are to be used exclusively for employees who have established seniority but have not attained the 24 points to be eligible for an annual pass, except as authorized in this Rule.

(B) A trip pass may be authorized for a new vehicle purchase that will be registered by the employee to be put on their annual pass, based on the requirements of Rule 33.07(A).

(C) Trip passes may be authorized to return employee vehicles to their home when employees complete a yard or lay-up period. In this circumstance the employee may also be authorized to accompany the vehicle while on duty.

(D) Trip passes may be authorized for special circumstances as determined by the Employer.

33.05 If the date of travel on an approved pass does not correspond with the actual date of travel, the employee and/or dependents involved must attempt to secure proper approval from Juneau Headquarters Office. Annual pass changes and trip pass requests must be made to the Pass Desk at Juneau Headquarters at least two (2) days prior to the requested travel date.

33.06 Open date and/or multiple date time frames for date of travel may be used at the discretion of the Juneau Headquarters issuing officer on an individual basis when authorizing trip passes.

33.07

(A) Personally-Owned Vehicle. An employee's personally-owned vehicle is defined as: Any non-commercial vehicle less than twenty-three (23) feet in length. The vehicle must be registered in the name of the employee, the employee's spouse or dependent child, or the employee must sign an affidavit to the effect that it will be registered in the name of the employee, the employee's spouse or dependent child upon arrival in Alaska and that the vehicle is for the use of the employee, the employee's spouse or dependent child and is not intended for resale within a period of one (1) year. For an active employee to have a POV shown on an Annual Pass, it must be registered and licensed by the State of Alaska.

(B) A vehicle and trailer may be transported on a trip pass basis subject to the following restrictions:

(1) A vehicle and trailer length will be determined as the connected length overall. The trailer must be towed by a vehicle listed on the employee's annual pass and

shall not be allowed to be transported unaccompanied. The first 23 feet will be allowed as free passage, any length over 23 feet will be based on the current fare tariff in place for the difference between the overall length and 23 feet of total connected length of vehicle and trailer.

(2) The fee charged does not provide confirmed reservations and transportation is still on a space available basis.

(3) If a trailer is to be transported in accordance with this Rule, the trailer is to be licensed for highway use.

33.08 Unauthorized use of or abuse of the pass privilege shall be cause for revocation of the employee's pass and possible disciplinary action.

33.09 When an employee is placed on disciplinary suspension, their pass privileges shall be revoked for the duration of the disciplinary suspension.

33.10 When an employee is terminated for cause their pass privileges are permanently revoked.

RULE 34 - MANAGEMENT CLAUSE AND UNION RIGHTS

34.01 Subject to the terms and conditions of this Agreement, the Employer retains the right and duty to manage its business, including but not limited to, the right to adopt regulations governing the appearance, dress, conduct and work procedures of its crew members as are reasonably required to maintain safety, efficiency, quality of service and the confidence of the traveling public.

34.02 The Union reserves the right to intercede on behalf of any employee who feels aggrieved because of the exercise of this right and to process a grievance in accordance with Rule 14.

34.03 The Employer shall not attempt in any manner to interfere or become otherwise involved in the internal affairs of the Union.

RULE 35 - DISCIPLINE

35.01 It is recognized the Employer has the right and duty to institute disciplinary actions against any employee who has committed an infraction of the Employer's policies, rules or regulations.

Discipline and discharge of permanent employees shall be for just cause. For purposes of this Rule, permanent employees are employees who have successfully completed the probationary period as outlined in Rule 4.01.

35.02 Certain offenses shall be grounds for immediate discharge including but not limited to: drinking alcoholic beverages or illegal use of drugs on board during the employee's workweek, or reporting to work under the influence, theft or willful

destruction of State property, insubordination, dishonesty, physical misconduct, accessing or viewing pornography at work or on a State computer, excessive absenteeism, falsifying records, leaving the vessel without being properly relieved or without permission of their department head; department heads shall obtain permission from the Master prior to leaving the vessel.

35.03 Ship's Union Delegate shall be present in any shipboard grievance procedure where suspension or discharge action against an employee covered under this Agreement is being considered.

35.04 All unlicensed vessel employees of the AMHS will be required to be tested for illegal substance use prior to hiring, on reasonable suspicion, after a serious marine incident, and randomly on a periodic basis. Employees who test positive will be suspended from duty without pay or benefits pending an investigation. After a hearing and determination by the Employer of a violation of the Employer's drug and alcohol policy, the employee will be subject to discipline up to and including dismissal. If the USCG revokes an employee's documents, the employee will be terminated.

The Employer will accept applications for employment from a former employee discharged for a positive drug test who has completed a drug rehab program and regains USCG documents.

RULE 36 - CONDITIONS NOT SPECIFICALLY COVERED

In the event operating conditions or service requirements arise due to length of voyage or other reasons not specifically covered by the Agreement, the Employer recognizes its obligations to negotiate on mandatory subjects of collective bargaining covered by law. The parties agree to negotiate immediately for the purposes of arriving at a mutually satisfactory supplemental agreement covering such operation.

RULE 37 - RESTRICTIONS, SAVING AND SEPARABILITY

37.01 It is understood that the Agreement at all times shall be applied subject to Federal laws, State laws and Executive Orders to the extent that these apply to the employees.

37.02 If any rule of this Agreement or any addenda thereto should be held invalid by operation of law or by any tribunal or body of competent jurisdiction or if compliance with or enforcement of any rule should be restrained by such body or

tribunal, the parties shall enter into immediate collective bargaining negotiations for the purpose of arriving at a replacement of such rule.

RULE 38 - TERM OF AGREEMENT

This Agreement shall become effective July 1, 2011, unless otherwise specified and shall remain in effect through June 30, 2014, and shall be considered renewed from year to year thereafter between the parties unless either party gives written notice to the other of its desire to amend or terminate same during the period from November 1, 2013 to June 30, 2014.

The parties recognize that the monetary terms of this agreement are subject to legislative approval pursuant to AS 23.40.215. This agreement shall not be valid and enforceable unless and until approved by the Legislature. If the Legislature fails or refuses to approve this agreement, the parties will return to bargaining within five days and either party is free to use such rights as it might have pursuant to AS 23.40.070-260. Upon legislative approval, the agreement shall be in effect in all its terms, and the State recognizes that it is bound to its terms for the life of the agreement without regard to the level of funding so long as there exists an appropriation to support personal services expenditures by the Alaska Marine Highway System.

For the State of Alaska:

For the Inlandboatmen's Union of
the Pacific-Alaska Region:

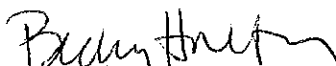

Becky Hultberg
Commissioner
Department of Administration

11-9-11
Date

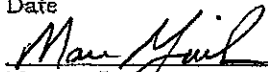

Marc Luiken
Commissioner
Department of Transportation
and Public Facilities

12-6-11

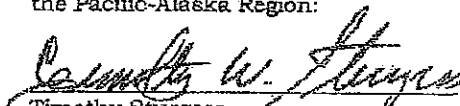

Timothy Sturgess
Regional Director
IBU-P

July 21, 2011
Date

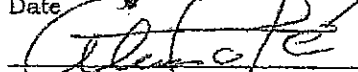

Alan Cote
President
IBU-P

July 21, 2011

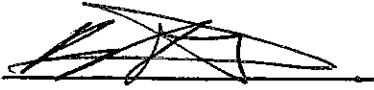

Benthe Mertl-Pasthumus
Chief Spokesperson

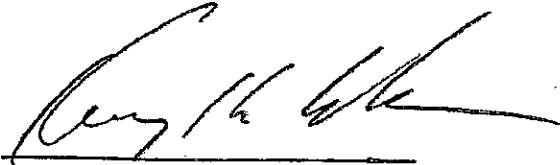

Kerry Crocker
Steward Representative

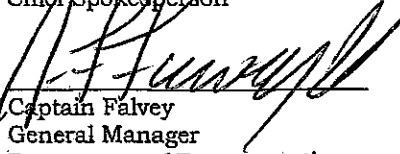

Captain Falvey
General Manager
Department of Transportation
and Public Facilities

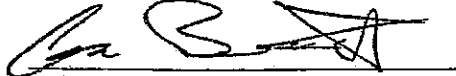

Gabe Bolshakoff
Deck Representative



Dallas Hargrave
Negotiator

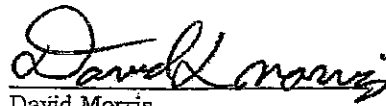

David Morris
Engine and SW Representative

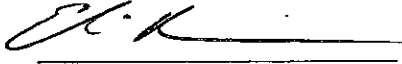

Elias Barger
Negotiator



Sondra Costales
Purscr Representative

LETTER OF AGREEMENT
between the
STATE OF ALASKA
and the
INLANDBOATMENS' UNION OF THE PACIFIC
Re: Port Lions, Chenega Bay, Tatitlek

12-II-015

It is hereby understood and agreed between the parties that the following is intended to supplement the Agreement entered into between the State of Alaska and the Inlandboatmens' Union of the Pacific to cover issues unique to providing service to Port Lions, Chenega Bay, and Tatitlek. Unless specifically superseded by an item on this letter of agreement, it is agreed that the following provisions supplement the Master Agreement.

The State of Alaska shall have the ability to contract for passenger and vehicle service from and to the port of Port Lions without regard to IBU jurisdiction.

The State of Alaska shall have the ability to contract for passenger and vehicle service from and to the port of Chenega Bay without regard to IBU jurisdiction.



The State of Alaska shall have the ability to contract for passenger and vehicle service from and to the port of Tatitlek without regard to IBU jurisdiction.

This agreement shall be effective upon signing and shall be coterminous with the 2011-2014 agreement.

This agreement is entered into solely to address the specific circumstance of this particular situation. It does not establish any practice or precedent between the parties. This agreement shall not be referred to in any other dispute, grievance, arbitration, hearing or any other forum, except as may be necessary for the execution of its terms.

FOR THE STATE OF ALASKA:

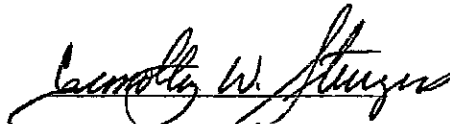
FOR THE UNION:



Nicki Neal

Timothy Sturgess

Director of Personnel and Labor Relations

Regional Director

11/10/2011

7-22-2011

Date

Date

SOA DOA Personnel

SEP 20 2011

Directors Office

SUPPLEMENTAL AGREEMENT
to the
COLLECTIVE BARGAINING AGREEMENT
between the
STATE OF ALASKA
and the
INLANDBOATMEN'S UNION OF THE PACIFIC, ALASKA REGION
Re: **SOUTHWEST SYSTEM**

It is hereby understood and agreed between the parties that the following is intended to supplement the 2011-2014 Agreement entered into between the State of Alaska and the Inlandboatmen's Union of the Pacific, Alaska Region, and is intended to amend that Agreement to cover the issues unique to the SOUTHWEST SYSTEM.

The Agreement without this Supplement is intended to cover the Southeast System. The entire Southeast System Agreement is intended to apply to the Southwest System unless a rule or a subsection of a rule is specifically modified, amended, or otherwise superseded by this Supplemental.

RULE 12 - TRAVEL BETWEEN ASSIGNMENTS

12.01 Home terminal for the M/V TUSTUMENA shall be Homer. Crews shall be relieved at the same terminal where they began their duties and such terminal shall be designated by the Employer as the home terminal. Relief or replacements made other than at their home terminal will be furnished transportation from their home terminal to place of employment and return transportation to their home terminal after completion of assignment, or from point of relief to their home terminal. Crew members shall be entitled to free transportation on vessels of the Employer between regular ports of call in which they reside and the home terminal at the commencement and termination of each period of duty. Crew members living in cities other than their home terminal will be able to secure passes through terminal agents either by teletype or telephone, if that terminal has no teletype. Changes in personnel (relief or replacement) shall take place at the vessel's home terminal whenever possible. Changes at other than the vessel's home terminal must be specifically authorized by the Employer.

12.05 - TRAVEL BETWEEN HOME TERMINALS – DISPLACED REGULARLY ASSIGNED EMPLOYEES, RELIEF, AND REGULARLY ASSIGNED RELIEF EMPLOYEES

Relief Employees, RAREs, and DRAEs shall have a home terminal of Homer. When a Relief Employee, RARE or DRAE receives an assignment at other than their preferred home terminal, the employee shall receive receipted necessary travel expenses for travel between the assignment and the preferred home terminal. However, if a Regularly Assigned Employee has become a Relief Employee or a DRAE as the result of a temporary upgrade or an assignment change at the

convenience of the Employer, the Relief Employee or DRAE shall also be entitled to travel pay for travel to and from the temporary upgrade or assignment change.

RULE 16 - SHIPYARD, MANNED LAY-UP, AND TERMINAL WORK

16.02 All time worked during a forty-two (42) hour workweek assignment in excess of eight and four-tenths (8.4) hours per day or five (5) consecutive days of forty-two (42) hours per week shall be paid at the overtime rate. In computing weekly overtime hours, the ship's watch time and shipyard, lay-up, or tie-up time on the forty-two (42) hour week schedule shall not be combined.

16.07

(A) Upon entering shipyard, lay-up, or tie-up status, Southwest Rule 17 and Rule 25 shall apply until the end of the bi-weekly pay period in which the vessel enters shipyard, lay-up, or tie-up status.

(B) During shipyard, lay-up, or tie-up status, Southeast Rule 17 and Rule 25 shall apply. The Employee may cash in "A" days in one (1) day increments not to exceed their normal rate of pay as provided in Southwest Rule 17. It shall be the employee's obligation to submit requests for "A" Day cash in with the appropriate time sheet.

(C) Upon leaving shipyard, lay-up, or tie-up status the entire Southwest Supplemental Agreement shall apply except that Southeast Rule 17 and Rule 25 shall apply until the end of the semimonthly pay period in which the vessel enters revenue service.

RULE 17 - PAY PLAN

17.01 This Agreement includes a pay plan providing a cost-of-living differential between employees living in the State and those living outside the State in accordance with AS 23.40.210.

Cost of Living Differential (COLD) payments are a geographical differential which reflects the difference in the cost of living in Alaska and Seattle, Washington. An employee establishes eligibility for COLD payments by establishing and maintaining their principal place of abode within the State.

Proof of eligibility for COLD payments must be filed annually on a form provided by the AMHS. The Employer may require an employee to provide additional documentation to support claims of eligibility for COLD payments. It shall be the employee's obligation to notify the Employer when they relocate their principal place of abode in a manner that affects eligibility for COLD.

(A) Salaries for Alaska residents, effective July 1, 2011:

CLASSIFICATION	STRAIGHT-TIME HOURLY	OVERTIME HOURLY
Chief Purser	\$ 26.71	\$ 44.66
A/B Bos'n	\$ 24.13	\$ 39.89
Able Seaman	\$ 22.09	\$ 36.51

Ordinary Seaman	\$ 20.79	\$ 34.20
Ordinary Seaman- Porter	\$ 20.79	\$ 34.20
Watchman-Porter	\$ 20.79	\$ 34.20
Junior Engineer	\$ 25.02	\$ 41.34
Oiler	\$ 22.98	\$ 37.91
Wiper	\$ 20.97	\$ 34.47
Chief Steward	\$ 26.71	\$ 44.66
Chief Cook	\$ 24.54	\$ 40.68
Second Cook	\$ 21.64	\$ 35.78
Assistant Second Cook	\$ 20.59	\$ 33.92
Bartender	\$ 20.59	\$ 33.92
Headwaiter	\$ 20.59	\$ 33.92
Head Bedroom Steward	\$ 20.59	\$ 33.92
Mess Steward	\$ 20.49	\$ 33.78
Officer's B/R	\$ 20.37	\$ 33.53
Waiter/Waitress	\$ 20.37	\$ 33.53
Steward	\$ 20.37	\$ 33.53

(D) Salary schedule for employees residing outside Alaska, effective July 1, 2011:

CLASSIFICATION	STRAIGHT-TIME HOURLY	OVERTIME HOURLY
Chief Purser	\$ 22.00	\$ 36.95
A/B Bos'n	\$ 20.40	\$ 32.60
Able Seaman	\$ 18.03	\$ 29.79
Ordinary Seaman	\$ 16.95	\$ 27.90
Ordinary Seaman- Porter	\$ 16.95	\$ 27.90
Watchman-Porter	\$ 16.95	\$ 27.90
Junior Engineer	\$ 20.79	\$ 33.77
Oiler	\$ 18.75	\$ 30.95
Wiper	\$ 17.12	\$ 28.14
Chief Steward	\$ 22.00	\$ 36.95
Chief Cook	\$ 20.04	\$ 33.17
Second Cook	\$ 17.68	\$ 29.16
Assistant Second Cook	\$ 16.80	\$ 27.66
Bartender	\$ 16.80	\$ 27.66
Headwaiter	\$ 16.80	\$ 27.66
Head Bedroom Steward	\$ 16.80	\$ 27.66
Mess Steward	\$ 16.74	\$ 27.54
Waiter/Waitress	\$ 16.66	\$ 27.44

Steward

\$ 16.66

\$ 27.44

Effective July 1, 2012, the straight time hourly rate of pay (in effect June 30, 2012) for all classifications shall increase by two percent (2%).

Effective July 1, 2013, the straight time hourly rate of pay (in effect June 30, 2013) for all classifications shall increase by one percent (1%).

17.06 An employee's "A" day balance will be totaled on the employee's time sheet at least once every quarter.

RULE 18 - HOURS

18.01 Deck and Engine Room Departments. Eight (8) hours shall constitute a day's work. Watchstanding crews shall be divided into sea watches, each watch standing four (4) hours on duty followed by eight (8) hours off duty. Two (2) such watches shall constitute a day's work. Day workers, when any are assigned, shall work between the hours of 8:00 a.m. and 4:30 p.m. exclusive of thirty (30) minutes for lunch.

18.02 Watchman. Any eight (8) consecutive hours shall constitute a day's work.

18.03 Steward's Department. Employees in the steward's department shall work eight (8) hours per day within a spread of thirteen (13) hours.

RULE 19 - BREAKING WATCHES

19.01 If the vessel is taken out of service, watches can be broken at either twelve noon or midnight, and the watchstanding crew members assigned to day work between the hours of 8:00 a.m. and 4:30 p.m., exclusive of thirty (30) minutes for lunch.

RULE 21 - SCHEDULING TIME OFF

21.01 Leave or time off requests must be received by the Crew Scheduling Office thirty (30) working days prior to the requested day of release. Approval or disapproval of the leave or time off request will be provided to the employee not later than twenty (20) working days prior to the requested day of release. To qualify under this Rule the leave or time off request must be approved by the department head and identify a qualified relief.

Leave requests shall not be canceled except in an emergency. In the event that employees are subsequently required to work on or beyond their first scheduled day of leave or are called back to work prior to the end of their scheduled leave, the employees shall be paid at the overtime rate for each day of work within the scheduled leave period up to a maximum of fourteen (14) days at the overtime

rate. Employees may submit leave or time off requests later than deadline above, but the deadline for the Employer's response and overtime penalty will not apply.

21.02. Shipboard department heads may request assistance from the Crew Scheduling Office in the event of insufficient reliefs.

RULE 22 – OVERTIME

22.02 All work performed off watch or in excess of eight (8) hours per day, shall be paid for at the overtime rate of pay applicable to the classification.

22.03 Does not apply.

RULE 23 - ACCUMULATED DAYS OFF

23.01 For each day worked and for each day a crew member is required to remain on board, such crew member shall accumulate time off with pay according to the following schedule:

Employees hired April 1, 1985, and after:

Years in System	Accrual Rate
0 but less than 2	1/2 day
2 but less than 5	5/8 day
5 but less than 7	3/4 day
7 or more	7/8 day

Employees hired prior to April 1, 1985:

Years in System	Accrual Rate
0 but less than 2	1/2 day
2 but less than 3	2/3 day
3 but less than 7	3/4 day
7 but less than 9	7/8 day
9 or more	1 day

For each holiday worked and for each holiday a crew member is required to remain on board, such crew member shall accumulate one and one-half (1-1/2) days off with pay. This accrual includes the accrual rate as provided for above. Changes in accrual rates shall be effective on the first day of the month following fulfillment of the service requirement.

Provisions of this Rule are in effect while the vessel is in service and during periods of shipyard or lay-up time.

23.02 When in ports other than the home port, crew members shall be given Saturday, Sunday and holidays off with pay. If any crew member is required to work by the vessel, or is ordered to remain aboard for security reasons, such crew

member shall receive the straight-time rate of pay and in addition thereto shall earn the appropriate number of accumulated days off with pay.

23.07 - UNION BUSINESS LEAVE

(A) All members shall donate one (1) day of accumulated time off when the member's balance is at least fourteen (14) days or more. Such vacation shall be converted to dollars at the hourly rate of the donor and transferred to the Union Business Leave Bank. Withdrawal requests from the Bank will be for purposes of contract negotiations, executive meetings, training sponsored by the Union and other purposes as may be determined by the Regional Director. Requests for withdrawal from the Bank shall be made only by the Regional Director to the Director of Personnel on forms mutually agreed on by the parties and furnished by the Union. All "A" Days transferred to the Bank is final and not recoverable for recredit to an individual's "A" Day account.

(B) Employees shall be allowed to voluntarily donate –A" Days to the Union Business Leave Bank, subject to the following procedures and conditions:

(1) Each employee wishing to donate "A" Days will fill out, date and sign a request showing the amount of accumulated time off they wish to donate.

(2) Each such request will have written or typed along the bottom, "A" Day donation to Inlandboatmen's Union of the Pacific, Alaska Region, Union Business Leave Bank."

(3) Inlandboatmen's Union of the Pacific, Alaska Region, will deliver all such "A" Day requests to the Alaska Marine Highway System. The vacation hours shall then be converted to dollars at the hourly rate of the donor and be transferred to the Union Business Leave Bank.

(4) The Employer will not be responsible for the collection, or any statements made in relation to the collection, of said donations.

(5) All donations are final and not recoverable for recredit to the donor's account.

(6) It is understood that such voluntary "A" Day donations are in addition to the mandatory "A" Day donation of one (1) day required under Rule 23.08(A).

(C) The release of members from duty for Union Business Leave shall be handled on the same basis as release for vacation. Approval for such release shall not be unreasonably withheld by the Employer.

23.08 - COURT LEAVE

(B) It shall be the continued practice of the Employer to pay for that time which is physically served as a witness for the State, as a juror or assisting the State's attorney in case preparation. Court leave will not be paid to employees not otherwise scheduled to work. The Employer shall continue the practice of working with court officials to schedule jury duty during scheduled time off. Employees

may use "A" days or vacation for time away from work but not serving as a State witness, juror or assisting the State's attorneys.

23.12 - MAXIMUM ACCUMULATION OF "A" DAYS

(A) "A" Days accrued but not used shall accumulate to a maximum of one hundred eighty (180) days on June 30 of any calendar year. If an employee has, as of June 30, an amount of "A" Days in excess of one hundred eighty (180) days, the excess shall be deducted from the employee's "A" Day balance. However, if circumstances cause the Employer to refuse an employee's timely request for "A" Days, the number of "A" Days refused will be carried over.

23.13 - "A" DAY CASH IN

Employees covered by this section who have "A" Day balances of at least fifteen (15) "A" Days, and who established eligibility for "A" Days at least ten (10) years ago shall be permitted to cash out fifteen (15) "A" Days per calendar year. The employee's "A" Day balance shall be reduced by the number of days for which payment is made.

RULE 24 - HOLIDAYS

24.03 All holidays will be paid at the eight (8) hour rate. Employees required to work on a holiday on their assigned day off will be paid at the overtime rate and in addition shall be granted one (1) additional day's pay at straight-time. Assigned days off refer to the schedule two (2) consecutive days off while at a shipyard, lay-up, or tie-up terminal as provided for in Rule 16.03 and vacation time. Pay for a holiday which occurs while an employee is on sick leave will be eight (8) hours holiday pay at straight-time rate and such hours will not be charged to sick leave balances.

RULE 25 - MINIMUM GUARANTEE

25.01

(A) Regularly Assigned Employees working as part of the crews shall receive not less than bi-weekly pay (one hundred and twelve [112] hours per pay period). Holiday Premium Pay, overtime worked beyond the basic straight-time day and the premium portion of overtime shall be paid in addition to the guarantee.

(B) No Employee shall be displaced with less than fourteen (14) days worked. This does not apply to crew members engaged as extras to relieve crew members for illnesses.

25.02 SHOW-UP PAY. When a relief is dispatched and reports to a job, they shall be guaranteed a minimum of a full day's pay eight (8) hours for the assignment.

25.03 Does not apply.

SUPPLEMENTAL AGREEMENT
to the
COLLECTIVE BARGAINING AGREEMENT
between the
STATE OF ALASKA
and the
INLANDBOATMEN'S UNION OF THE PACIFIC (Alaska Region)
Re: **M/V KENNICOTT**

This supplemental agreement will govern the wages, hours and terms and conditions of crew members assigned to the M/V KENNICOTT. Any renumbering of contract rules necessitated by this supplemental, whether or not specifically incorporated herein, shall be regarded by the parties as purely administrative detail and such renumbering (or lack thereof) shall not diminish or impair the substantive terms of this agreement.

Unless specifically modified by the terms of this Supplemental Agreement, all provisions of the parties' Master Agreement governing Southeast System operations shall remain in effect. This supplemental agreement is intended to address the unique operating conditions and capabilities of the M/V KENNICOTT. If any rule or subsection of the Master Agreement conflicts with this Supplemental, the provisions of this Supplemental shall apply.

Rule 18.01. Add a new last sentence: When a three watch system is in effect sea watches for watchstanders are four (4) hours in duration.

Rule 19.01. Two (2) complete crews shall be assigned to M/V KENNICOTT with the workdays divided evenly during each year between the two (2) crews as nearly as practicable. Each crew will work two (2) weeks followed by two (2) weeks off duty with the alternate crew relieving. The provisions of this Rule shall not apply to shipyard, lay-up, or tie-up time.

Rule 25.01(A). All Regularly Assigned Employees shall receive in wages not less than one hundred sixty eight (168) times the employee's straight-time hourly rate for each assignment. Minimum guarantee will not apply if the employee only works the first day of the pay period when entering or leaving a yard.

Rule 25.01(B). All Relief Employees, RAREs and DRAEs shall receive in wages not less than one hundred sixty eight (168) hours straight-time pay for each assignment.

If M/V KENNICOTT is scheduled to operate in the Southwest System for more than thirty (30) consecutive days, the Union may request to meet and confer with the Employer regarding issues arising from that schedule.

SUPPLEMENTAL AGREEMENT
to the
COLLECTIVE BARGAINING AGREEMENT
between the
STATE OF ALASKA
and the
INLANDBOATMENS UNION OF THE PACIFIC
Re: M/V FAIRWEATHER

It is hereby understood and agreed between the parties that the following is intended to supplement the Agreement entered into between the State and the IBU, and is intended to amend those Agreement to cover the issues unique to the M/V Fairweather. The Master Agreement is intended to apply to the M/V Fairweather unless specifically superseded by a Rule or a subsection of a Rule in this Supplemental Agreement.

Rule 8- Health and Safety

There are no quarters aboard the M/V Fairweather. Any reference to quarters, private toilet facilities and mess rooms are not applicable.

Rule 9- Occupational Injury and Illness

9.01 Unearned Wages: In the event a crewmember becomes ill or is injured while in the service of the M/V Fairweather, he/she will receive wages to the end of the workday. In the event that a crewmember becomes injured while in the service of the M/V Fairweather, and a report is filed and not successfully controverted, he/she will be entitled to wages for three working days or less, if not later compensated.

Rule 11 - Cash Allowance for Subsistence and Quarters

11.01 When a crewmember is in work status, and remains away from the assigned change port overnight, they shall be entitled to a quarters allowance in accordance with the Master Agreement.

11.02 When a crewmember is in work status, and is away from the assigned change port for more than two (2) hours outside normal duty hours, they shall be entitled to a meal allowance in accordance with the Master Agreement.

Rule 15- Working Conditions

15.02 Does not apply.

15.03 When tying up or letting go, no less than two (2) crewmembers shall be assigned to each tie up station and not less than one employee per line as it is being handled.

15.04 Upon direction of the Licensed Engineer the unlicensed engine room personnel may be required to take on ships fuel oil, lube oil, fresh water, and the handling of ship-to-shore and shore-to-ship power cables.

15.05 Crewmembers working a twelve (12) hour shift shall receive a one-half (1/2) hour duty-free paid meal period. Every effort shall be made to provide the meal break midway through the shift. All members shall be allowed two (2) paid fifteen (15) minute relief periods in each normal workday.

15.07, 15.08, 15.09, 15.10, do not apply

15.11 In the event future operations require Oilers and /or Junior Engineers he/she may be required to perform normal wiper duties without payment of penalty pay.

15.13 (F) Crewmembers awarded bid positions aboard the M/V Fairweather will receive in-house type and craft training necessary to work on that vessel. All classroom training, prior to becoming type and craft rated shall be considered training operations. During training operations, all hours in port in excess of eight and four-tenths (8.4) hours per day or five days, forty-two (42) hours per week shall be paid at the overtime rate of one and one-half times the hourly rate. All training aboard the M/V Fairweather, while on the run, will be paid at 12 hours at the straight-time rate of pay.

Rule 16- Shipyard and Terminal Work

When the vessel is in maintenance/lay-up status, the Employer shall determine crew requirements. For any yard period schedule to be less than three weeks in duration, the crew and working hours will remain the same as if the vessel was on run time. Rules 16.01, 16.02 and 16.03 shall not apply if the vessel remains on run time.

In yard period of in excess of three weeks the provisions of the Master agreement shall apply.

Rule 17- Pay Plan

17.01 (A) In the pay period following the mutual agreement of this supplemental the following shall apply:

Hourly Rates: Regular time Overtime

Passenger Services Worker-in charge \$31.26 \$ 46.89

Deck Rating \$ 25.54 \$ 38.31
Passenger Services Worker \$.23.46 \$ 35.19
Wiper \$ 24.12 \$36.18

Effective July 1, 2012, the straight time hourly rate of pay (in effect June 30 2012) for all classifications shall increase by two percent (2%).

Effective July 1, 2013, the straight time hourly rate of pay (in effect June 30, 2013) for all classifications shall increase by one percent (1%).

17.02 Does not apply.

17.09 Lost wages will only be paid if a crewmember has the necessary requirements to work aboard the M/V Fairweather and is not dispatched consistent with their seniority.

Rule 18- Hours—Vessel on the Run

18.01 Twelve hours shall constitute a day's work. There will be no splitting in shifts within a 12-hour day.

18.02 Does not apply.

Rule 21- Late Arrival

Does not apply.

Rule 26 - Seniority

All crewmembers working aboard the M/V Fairweather will be credited seniority points retroactive to their first assignment to the M/V Fairweather.

Seniority points will be credited as follows:

PSW-IC earns seniority as a PSW-IC
Deck Rating earns seniority as an AB
PSW earns seniority as an OS/Porter
Wipers earn seniority as a Wiper

28.10 Probationary Crewmember: For the purposes of performance review, all crewmembers shall be considered probationary during type and craft rating for a minimum of six (6) months. For purposes of the probationary period while assigned to the M/V Fairweather Rule 17.02 will not apply.

Winter Operations

It is anticipated that between September 16 and May 15, the M/V Fairweather will enter its winter operations providing reduced service. Rule 19 of the Master Agreement shall be modified as follows: One crew will work four days on, followed by three days off. Daily schedules will be determined by operational schedule. Permanently assigned crewmembers of the M/V Fairweather shall be guaranteed 42 hours of work or pay.

Those employees that do not have sufficient seniority to work aboard the M/V Fairweather during winter operations will become DRAEs and the provisions of Rule 27.01 (E) shall apply.

Overtime for work on assigned days off: When a crewmember holding a bid job on the M/V Fairweather has worked a regularly assigned workweek and is required to work on his/her days off, he/she shall be paid at the overtime rate of time and one-half for the time worked.

Overtime for work in excess of 42 hours per work week: When a crewmember holding a bid job on the M/V Fairweather has worked in excess of 42 hours per workweek, he/she shall be paid at the overtime rate of time and one-half for the time worked.

The Employer will make every attempt to provide a 30 day notice to the Union of the commencement and completion of winter operations. The Employer shall give at least ten (10) working days written notice.

LETTER OF AGREEMENT
between the
State of Alaska
and the
INLANDBOATMEN'S UNION OF THE PACIFIC
M/V Chenega (2011-2014)

In the interest of arriving at a mutually satisfactory agreement, it is hereby understood and agreed between the parties that the following is intended as an addendum to the Master Agreement entered into between the State of Alaska and the Inlandboatmen's Union of the Pacific, Alaska Region and is intended to amend that Master Agreement only in regard to issues unique to the Fast Vehicle Ferry M/V Chenega. The Master Agreement without this Letter of Agreement is intended to apply to the Fast Vehicle Ferry M/V Chenega unless an entire Rule or subsection of a Rule is specifically modified, amended, or otherwise superseded by this Letter of Agreement. The Master Agreement is not modified other than as specifically addressed in the Fast Vehicle Ferry M/V Chenega Letter of Agreement. The home terminal for the M/V Chenega shall be Cordova, Alaska.

Rule 8- Health and Safety

There are no quarters aboard the M/V Chenega. Any reference to quarters, private toilet facilities and mess rooms are not applicable.

Rule 9 - Occupational Injury and Illness

9.01 Unearned Wages: In the event a crewmember becomes ill or is injured while in the service of the M/V Chenega, he/she will receive wages to the end of the workday. In the event that a crewmember becomes injured while in the service of the M/V Chenega, and a report is filed and not successfully controverted, he/she will be entitled to wages for three working days or less, if not later compensated.

Rule 11 - Cash Allowance for Subsistence and Quarters

11.01 When a crewmember is in work status, and remains away from the assigned change port overnight, they shall be entitled to a quarters allowance in accordance with the Master Agreement.

11.02 When a crewmember is in work status, and is away from the assigned change port for more than two (2) hours outside normal duty hours, they shall be entitled to a meal allowance in accordance with the Master Agreement.

Rule 15 – Working Conditions

15.06 Does not apply.

15.07 When tying up or letting go, no less than two (2) crewmembers shall be assigned to each tie up station and not less than one employee per line as it is being handled.

15.08 Upon direction of the Licensed Engineer the unlicensed engine room personnel may be required to take on ships fuel oil, lube oil, fresh water, and the handling of ship-to-shore and shore-to-ship power cables.

15.09 Crewmembers working a twelve (12) hour shift shall receive a one-half (1/2) hour duty-free paid meal period. Every effort shall be made to provide the meal break midway through the shift. All members shall be allowed two (2) paid fifteen (15) minute relief periods in each normal workday.

15.07, 15.08, 15.09, 15.10, do not apply.

15.11 In the event future operations require Oilers and /or Junior Engineers he/she may be required to perform normal wiper duties without payment of penalty pay.

15.13 (F) Crewmembers awarded bid positions aboard the M/V Chenega will receive in-house type and craft training necessary to work on that vessel. All classroom training, prior to becoming type and craft rated shall be considered training operations. During training operations, all hours in port in excess of eight and four-tenths (8.4) hours per day or five days, forty-two (42) hours per week shall be paid at the overtime rate of one and one-half times the hourly rate. All training aboard the M/V Chenega, while on the run, will be paid at 12 hours at the straight-time rate of pay.

Rule 16 – Shipyard and Terminal Work

For any yard or maintenance period scheduled to be three (3) weeks or less in duration, which may be extended by mutual agreement, the working hours, crew, and all other terms and conditions of the Master Agreement shall apply as if the vessel is in underway status and twelve (12) consecutive hours shall constitute a days work. During this status, the provisions of Rule 16.01, 16.02, and 16.03 shall not apply.

If the yard or maintenance period is scheduled for longer than three (3) weeks in duration, or as extended by mutual agreement, the provisions of Rule 16 of the Master Agreement shall apply.

When the vessel is in lay-up status, the Employer shall determine crew requirements, and the appropriate time periods and terms and conditions as described above shall apply.

Rule 17 – Pay Plan

Add to Rule 17.01 (A)

Job Classification	Hourly Rate	Hourly Overtime Rate
Passenger Service Worker-In Charge	\$ 31.26	\$ 46.89
Deck Rating Passenger Service Worker	\$ 25.54	\$ 38.31
Wiper	\$24.12	\$36.18

Effective July 1, 2012, the straight time hourly rate of pay (in effect June 30 2012) for all classifications shall increase by two percent (2%).

Effective July 1, 2013, the straight time hourly rate of pay (in effect June 30, 2013) for all classifications shall increase by one percent (1%).

17.02 Does not apply.

17.09 Lost wages will only be paid if a crewmember has the necessary requirements to work aboard the M/V Chenega and is not dispatched in accordance with their seniority.

Rule 18- Hours—Vessel on the Run

18.01 Twelve(12) consecutive hours shall constitute a day's work. There will be no splitting in shifts within a 12-hour day. All work in excess of the twelve (12) consecutive hours shall be compensated at the overtime rate and the provisions of Rule 22 shall apply.

18.02 Does not apply.

Rule 21 – Late Arrival

Does not apply.

Rule 22 – Overtime

Overtime for work on assigned time off: When a crewmember assigned to the M/V Chenega has worked a regularly assigned workweek and is required to work on his/her time off, he/she shall be paid at the overtime rate of time and one-half for the time worked.

Overtime for work when on a 4 day on 3 day off schedule: When a crewmember assigned to the M/V Chenega has worked in excess of 42 hours per work week, or more than 12 hours in a day he/she shall be paid at the overtime rate of time and one-half for the time worked.

Rule 23- Vacation

Vacation shall normally be taken during time of winter operations. Crewmembers of the M/V Chenega may be granted up to two weeks of vacation during the period of May through September. Requests for additional leave during summer operations will be considered on a case-by-case basis.

Rule 26 – Seniority

All crewmembers working aboard the M/V Chenega will be credited seniority points retroactive to their first assignment to the M/V Chenega.

Seniority points will be credited as follows:

PSW-IC earns seniority as a PSW-IC

Deck Rating earns seniority as an AB

PSW earns seniority as an OS/Porter

Wipers earn seniority as a Wiper

28.10 Probationary Crewmember: For the purposes of performance review, all crewmembers shall be considered probationary during type and craft rating for a minimum of six (6) months. For purposes of the probationary period while assigned to the M/V Chenega Rule 17.02 will not apply.

Winter Operations

It is anticipated that between September 16 and May 15, the M/V Chenega will enter its winter operations providing reduced service. Rule 19 of the Master Agreement shall be modified as follows: One crew will work four days on, followed by three days off. Daily schedules will be determined by operational schedule. Permanently assigned crewmembers of the M/V Chenega shall be guaranteed 42 hours of work or pay.

Those employees that do not have sufficient seniority to work aboard the M/V Chenega during winter operations will become DRAEs and the provisions of Rule 27.01 (E) shall apply.

Overtime for work on assigned days off: When a crewmember holding a bid job on the M/V Chenega has worked a regularly assigned workweek and is required to work on his/her days off, he/she shall be paid at the overtime rate of time and one-half for the time worked.

Overtime for work in excess of 42 hours per work week: When a crewmember holding a bid job on the M/V Chenega has worked in excess of 42 hours per workweek, he/she shall be paid at the overtime rate of time and one-half for the time worked.

The Employer will make every attempt to provide a 30 day notice to the Union of the commencement and completion of winter operations. The Employer shall give at least ten (10) working days written notice.

This agreement shall be effective upon signing and shall be coterminous with the Master Agreement unless extended or cancelled with the mutual agreement of the parties.

SUPPLEMENTAL AGREEMENT
to the
COLLECTIVE BARGAINING AGREEMENT
between the
STATE OF ALASKA
and the
INLANDBOATMEN'S UNION OF THE PACIFIC
M/V Lituya

It is hereby understood and agreed between the parties that the following is intended to supplement the Agreement entered into between the State of Alaska and the Inlandboatmen's Union of the Pacific, and is intended to amend that Agreement to cover the issues unique to the M/V Lituya. The entire Southeast System Agreement is intended to apply to the M/V Lituya unless an entire Rule or a subsection of a Rule is specifically modified, amended, or otherwise superseded by this Supplemental.

RULE 9 – OCCUPATIONAL INJURY AND ILLNESS BENEFITS

9.01 Unearned Wages: In the event a crewmember becomes ill or is injured while in the service of the M/V Lituya, they will receive wages to the end of the scheduled workday. In the event that a crewmember becomes injured while in the service of the M/V Lituya, and a report is filed and not successfully controverted, they will be entitled to wages for three working days or less, if not later compensated.

RULE 12 – CHANGE PORTS AND TRAVEL BETWEEN ASSIGNMENTS

12.01 The home/change port shall be Metlakatla.

RULE 15 – WORKING CONDITIONS

15.02, 15.04, 15.05, 15.08, 15.10, 15.11, do not apply.

RULE 16 – SHIPYARD, MANNED LAY-UP, AND TERMINAL WORK

16.01 When vessels are tied up and watches are broken such as at a shipyard or tie-up terminal, those crewmembers assigned to the vessel shall work a forty-two (42) hour workweek.

16.02 All time worked during a forty-two (42) hour workweek assignment in excess of (42) hours a week shall be paid at the overtime rate of one and one half times the applicable hourly rate.

16.03 Any crew members assigned to the M/V Lituya while tied up at shipyards, lay-up, or tie-up terminals who are working a forty-two hour (42)work week may be assigned to work periods of five consecutive days on duty and two (2) consecutive days off and will not receive overtime penalty pay as such for working on Saturday and Sunday. If called back on their assigned days off they will be paid the overtime rate for time worked. Assigned days off refer to two consecutive days only.

16.04, 16.05, 16.06 do not apply.

RULE 17 - PAY PLAN

The Lituya class employees will be paid as follows:

Straight-time hourly Overtime
Deck/Steward Utility \$22.80 \$34.20
Deck/Engine Utility \$25.27 \$37.91
Lituya Class AB \$25.27 \$37.91

Effective July 1, 2012, the straight time hourly rate of pay (in effect June 30 2012) for all classifications shall increase by two percent (2%).

Effective July 1, 2013, the straight time hourly rate of pay (in effect June 30, 2013) for all classifications shall increase by one percent (1%).

Rules 17.03 and 17.06 shall not apply.

RULE 18 - VESSEL ON THE RUN

18.01 The normal workday will not exceed twelve (12) hours. The normal workweek shall consist of forty-two (42) hours in pay status within five consecutive days with two (2) days off. A workday shall begin one half (1/2) hour prior to departure from the vessels home port and end one half hour after returning to the home port.

RULE 19 - MONTHLY WORK

Entire rule does not apply.

RULE 20 - EMERGENCY SERVICE

20.01 Emergency service such as collision, breakdown, standing to and rendering aid to another vessel or parties in distress shall not be considered overtime. The additional time shall be paid for only at the straight-time rate.

RULE 21 - LATE ARRIVAL

Entire rule does not apply.

RULE 22 - OVERTIME

Entire rule does not apply.

All time worked during a forty-two (42) hour workweek assignment in excess of (42) hours a week shall be paid at the overtime rate of one and one half times the normal hourly rate of pay.

For crewmembers assigned for less than a one week assignment overtime will be computed and paid daily (Overtime for any work over twelve (12) hours per day).

RULE 24 - HOLIDAYS

24.02 If a crewmember is required to work on a holiday, they shall be paid at the overtime rate for the actual hours worked and in addition, shall receive holiday pay of twelve (12) hours at the straight-time rate.

24.03 All holidays will be paid at the twelve (12) hour rate.

RULE 25 - MINIMUM GUARANTEE

25.01 The minimum pay for the crew that are regularly assigned Lituya shall not be less than forty-two (42) hours per week at the rate of pay listed in Rule 17 above. This provision shall not apply to crewmembers engaged as extras to relieve regularly assigned employees for vacations, illnesses or leaves of absence.

RULE 26 - SENIORITY

Crewmembers of the M/V Lituya shall establish seniority as follows:

<u>Classification:</u>	<u>Equivalent to:</u>
Deck/Steward Utility	Ordinary Seaman/Porter
Deck/Engine Utility	Oiler
Lituya class A/B	A/B

This agreement will expire concurrent with the Master Agreement.